

Dual Measurement Multimeter

GDM-904X Series

USER MANUAL

REV. A



ISO-9001 CERTIFIED MANUFACTURER

GW INSTEK

This manual contains proprietary information, which is protected by copyrights. All rights are reserved. No part of this manual may be photocopied, reproduced or translated to another language without prior written consent of Good Will company.

The information in this manual was correct at the time of printing. However, Good Will continues to improve products and reserves the right to change specifications, equipment, and maintenance procedures at any time without notice.

Good Will Instrument Co., Ltd.

No. 7-1, Jhongsing Rd., Tucheng Dist., New Taipei City 236, Taiwan (R.O.C.).

Table of Contents

SAFETY INSTRUCTIONS	5
Safety Symbols.....	5
Safety Guidelines	6
GETTING STARTED	9
Characteristics	10
Front Panel Overview	12
Rear Panel Overview	17
Status Bar.....	19
Set Up	22
BASIC MEASUREMENT	24
Basic Measurement Overview.....	26
AC/DC Voltage Measurement	29
AC/DC Current Measurement	34
2W Resistance Measurement.....	37
Continuity Test.....	39
Diode Measurement.....	41
Frequency/Period Measurement.....	42
Capacitance Measurement	46
Temperature Measurement	49
A.I. (Auto Identification) Measurement.....	51
DUAL MEASUREMENT	52
Dual Measurement.....	53
ADVANCED MEASUREMENT.....	62
Advanced Measurement Overview.....	63
Relative Value Measurement	64
Hold Measurement	66
Trigger Setting	68
Filter Setting.....	69
Math Measurement	72
SYSTEM & FIRMWARE	88
View System Info.....	89

MENU SETTING	90
Configure System	91
SCREENSHOT & LOG	100
Capture	101
Save Data Log	102
REMOTE CONTROL	106
Configure Interface	107
Command Syntax	114
Command Set	118
Status system.....	147
APPENDIX	148
Fuse Replacement.....	149
Battery Replacement.....	153
Factory Default Parameters	155
Specifications	158
Declaration of Conformity	165
INDEX	166

S SAFETY INSTRUCTIONS

This chapter contains important safety instructions that you must follow when operating the GDM-9041/9042 and when keeping it in storage. Read the following before any operation to ensure your safety and to keep the GDM-9041/9042 in the best possible condition.

Safety Symbols

These safety symbols may appear in this manual or on the GDM-9041/9042.



WARNING

Warning: Identifies conditions or practices that could result in injury or loss of life.



CAUTION

Caution: Identifies conditions or practices that could result in damage to the GDM-9041/9042 or to other property.



DANGER High Voltage



Attention Refer to the Manual



Protective Conductor Terminal



Earth (ground) Terminal



Do not dispose electronic equipment as unsorted municipal waste. Please use a separate collection facility or contact the supplier from which this instrument was purchased.

Safety Guidelines

General Guideline



CAUTION

- Make sure that the voltage input level does not exceed DC 1000 V/AC 750 V.
- Make sure the current input level does not exceed 12 A.
- Do not place any heavy object on the instrument.
- Avoid severe impact or rough handling that can lead to damaging the instrument.
- Do not discharge static electricity to the instrument.
- Use only mating connectors, not bare wires, for the terminals.
- Do not perform measurement at the source of a low-voltage installation or at building installations (Note below).
- Do not disassemble the instrument unless you are qualified as service personnel.

(Note) EN 61010-1:2010 specifies the measurement categories and their requirements as follows. The GDM-904X falls under category II 300 V.

- Measurement category IV is for measurement performed at the source of low-voltage installation.
- Measurement category III is for measurement performed in the building installation.
- Measurement category II is for measurement performed on the circuits directly connected to the low voltage installation.

Power Supply



WARNING

- AC Input voltage: 100/120/220/240 V AC $\pm 10\%$, 50/60 Hz
 - The power supply voltage should not fluctuate more than 10%.
 - Connect the protective grounding conductor of the AC power cord to an earth ground, to avoid electrical shock.
-

Power Cord Requirement	<p>If the equipment is used in a manner not specified by the manufacturer, the protection provided by the equipment may be impaired. Do NOT replace the detachable MAINS supply cords by inadequately RATED cords.</p> <p>Suitable supply cord set for use with the equipment:</p> <ul style="list-style-type: none"> ▪ Mains plug: Shall be national approval ▪ Mains connector: C13 type ▪ Cable: <ol style="list-style-type: none"> 1. Length of power supply cord: less than 3 m 2. Cross-section of conductors: at least 0.75 mm² 3. Cord type shall meet the requirements of IEC 60227 or IEC 60245 (e.g.: H05VV-F, H05RN-F)
Fuse  WARNING	<ul style="list-style-type: none"> • Fuse type: T0.315A 100/120 VAC T0.16A 220/240 VAC • Make sure the correct type of fuse is installed before power up. • To avoid risk of fire, replace the fuse only with the specified type and rating. • Disconnect the power cord before fuse replacement. • Make sure the cause of a fuse blowout is fixed before fuse replacement.
Cleaning the Instrument	<ul style="list-style-type: none"> • Disconnect the power cord before cleaning. • Use a soft cloth dampened in a solution of mild detergent and water. Do not spray any liquid into the GDM-9041/9042. • Do not use chemicals or cleaners containing harsh material such as benzene, toluene, xylene, and acetone.
Operation Environment	<ul style="list-style-type: none"> • Location: Indoor, no direct sunlight, dust free, almost non-conductive pollution (Note below) • Temperature: Full accuracy for 0°C to 50°C. • Humidity: <ul style="list-style-type: none"> < 35°C: < 80%RH (non-condensing) >35°C: <70%RH (non-condensing) • Altitude: <2000m

(Note) EN 61010-1 specifies the pollution degrees and their requirements as follows. The GDM-9041/9042 falls under degree 2.

Pollution refers to “addition of foreign matter, solid, liquid, or gaseous (ionized gases), that may produce a reduction of dielectric strength or surface resistivity”.

- Pollution degree 1: No pollution or only dry, non-conductive pollution occurs. The pollution has no influence.
- Pollution degree 2: Normally only non-conductive pollution occurs. Occasionally, however, a temporary conductivity caused by condensation must be expected.
- Pollution degree 3: Conductive pollution occurs, or dry, non-conductive pollution occurs which becomes conductive due to condensation which is expected. In such conditions, equipment is normally protected against exposure to direct sunlight, precipitation, and full wind pressure, but neither temperature nor humidity is controlled.

Storage Environment

- Location: Indoor
- Temperature: -10°C to 70°C
- Humidity: 0 to 35°C <90%RH(non-condensing)
>35°C <80%RH(non-condensing)

Disposal



Do not dispose this instrument as unsorted municipal waste. Please use a separate collection facility or contact the supplier from which this instrument was purchased. Please make sure discarded electrical waste is properly recycled to reduce environmental impact.

GETTING STARTED

This chapter describes the GDM-9041/9042 in a nutshell, including an Overview of its main features and front / rear panel introduction. After going through the Overview, follow the Power-up sequence to properly setup the GDM-9041/9042.

Please note the information in this manual was correct at the time of printing. However, as GW Instek continues to improve its products, changes can occur at any time without notice. Please see the GW Instek website for the latest information and content.

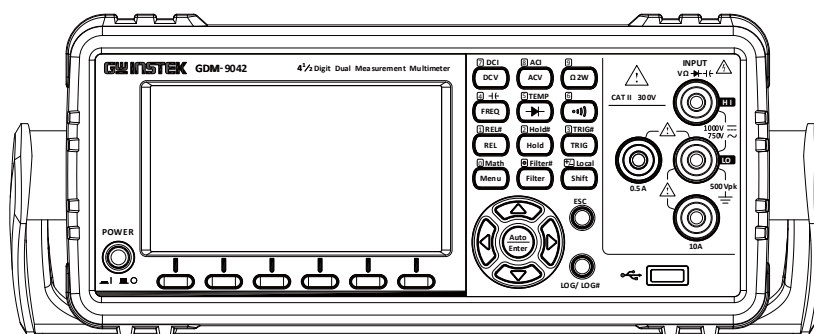

Characteristics	10
Accessories	11
Front Panel Overview	12
Measurement Keys (Basic)	15
Measurement Keys (Advanced)	16
Rear Panel Overview	17
Status Bar	19
Set Up	22
Horizontal/Tilt/Vertical Applications	22
Power Up	23

Characteristics

The GDM-9041/9042 is a portable, dual-display digital multimeter suitable for a wide range of applications, such as production testing, research, and field verification.

Performance	<ul style="list-style-type: none">• The highest DCV accuracy: 0.02%• The highest current: 10A• The highest voltage: 1000V• The highest ACV frequency response: 100 kHz
Features	<ul style="list-style-type: none">• 50000 count display• Multi functions: ACV, DCV, ACI, DCI, R, C, Hz, Temp*, Continuity, Diode test, MAX/MIN, REL, dBm, Hold, MX+B, 1/X, REF%, dB, Compare.• Manual or Auto ranging• AC true RMS• Data Logging to USB*• Data logging to PC using an Excel Add-In
Interface	<ul style="list-style-type: none">• USB device/ GPIB(optional)• USB device port supports USB CDC and USBTMC• USB Host for GDM-9042
Software	<ul style="list-style-type: none">• Excel Addins
 Note	*These features are only available on the GDM-9042



Accessories

Standard Accessories	Part number	Description
	82DM-90610MA1	Safety Instruction Sheet
	GTL-207A	Test leads: 1x red, 1x black
Optional Accessories	Part number	Description
	GTL-246	USB Cable, USB 2.0, A-B type, 1200 mm
	GTL-205A	Temperature Probe Adapter with Thermal Coupling (K-type)
	GTL-248	GPIB Cable, approx. 2000 mm
	GDM-TL1	<ul style="list-style-type: none"> ▪ Test lead probes with CAT IV 600 V sheath x 2 ▪ Fine tip probes x 2 ▪ SMT Grabbers x 2 ▪ Mini Grabber x 1
	GSC-014	Soft carrying case for DMM accessory
	GRA-422	Rack Mount Kit (19" 2U)
	GRA-454	Rack Mount Kit (19", 2U) for two sets

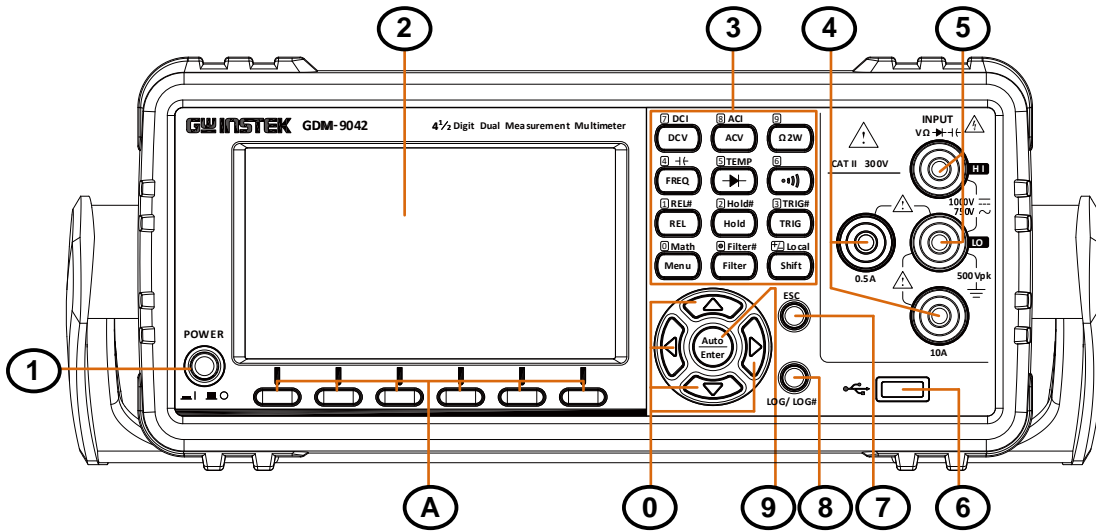
Front Panel Overview





Item	Description
1	Power Switch
2	Main Display
3	Measurement Keys
4	AC/DC Current Input Terminals
5	HI and LO Input Terminals
6	USB Host Port
7	ESC (Escape) Key
8	Screenshot / Data log Key
9	Auto Range/Enter Key
0	Arrow Keys
A	Function keys (F1 through F6, functions vary per modes)

Power Switch  Turn On  or Off  the main power. For the power up sequence, see page 23.

Main Display The 4.3" TFT LCD shows measurement results and parameters. For display configurations, see page 95.

Measurement Keys There are 4 rows in total of both basic and advanced measurement keys deployed on the front panel. For the details, refer to page 15 and page 16.





DC/AC 0.5A Terminal  DC/AC current input
 DC: 500 μ A to 0.5 A
 AC: 500 μ A to 0.5 A
 For DCI or ACI details, see page 34.

DC/AC 10A Terminal  Accept DC/AC Current input.
 DC: 5 A to 10 A
 AC: 5 A to 10 A
 For DCI or ACI details, see page 34.

















Input HI Terminal  Used as an input port for all measurements except for DC/AC Current measurements.

Input LO Terminal  Accept ground (COM) line in all measurements.
 The maximum withstand voltage between this terminal and earth is 500Vpk.

USB Host Port  Connect with USB flash drive for data storage.















ESC (Escape) Key		Single press to escape from current page to the previous page.
Screenshot / Data Log Saving Key		Capture the current screenshot or saves the data log for reading. For details, refer to page 100.
Range Selection / Enter Key		Press the Auto key to activate auto-range mode when under measurement display. Press the Enter key to confirm setting when under parameter configuration.
Arrow Keys		Press the left or right arrow key to move parameter cursor rightward or leftward. Press the up or down key to increase or decrease value for parameter configuration.
Function Keys	The 6 keys have varied functions per different settings.	

Measurement Keys (Basic)

Background		The upper 2 rows of measurement keys are used for basic measurements. Each key has a primary and secondary function individually. The secondary function is accessed in conjunction with the Shift key.
Shift		The Shift key is used to select the secondary functions assigned to each front panel key. When pressed, the Shift indicator appears in the display.
Local		For the Local key, it helps release from the remote control and returns the instrument to local panel operation (page 107).
ACV		Measures AC Voltage (page 29).
Shift → ACV (ACI)	 → 	Measures AC Current (page 34).
DCV		Measures DC Voltage (page 29).
Shift → DCV (DCI)	 → 	Measures DC Current (page 34).
Ω2W (Resistance)		Measures 2-wire Resistance (page 37).
••• (Continuity)		Tests Continuity (page 39).
→ (Diode)		Tests Diode (page 41).
FREQ (Frequency)		Measures Frequency (page 42).
Shift → FREQ (Capacitance ←)	 → 	Measures Capacitance (page 46).
Shift → → Diode (TEMP Temperature)	 → 	Measures Temperature (page 49).

Measurement Keys (Advanced)

Background The lower 2 rows of measurement keys are used for more advanced functions. Each key has a primary and secondary function. The secondary function is accessed in conjunction with the Shift key.

REL		Measures the Relative value (page 64).
Shift → REL (REL#)	 → 	Manually sets the reference value for the Relative value measurement (page 64).
Hold		Activates the Hold function (page 66).
Shift → Hold (Hold#)	 → 	Manually sets the parameters for the Hold measurement (page 66).
TRIG (Trigger)		Activates the Trigger function (page 68).
Shift → TRIG (TRIG#)	 → 	Sets the parameters for the Trigger function (page 68).
Menu		Enters the setting pages in various Menus (page 91).
Shift → Menu (Math)	 → 	The Math functions including dB, dBm, Compare, MX+B, 1/X and Percent manually (page 72).
Filter		Manually sets the parameters for the Filter function (page 69).
Shift → Filter (Filter#)	 → 	Activates the Filter function (page 69).

Rear Panel Overview

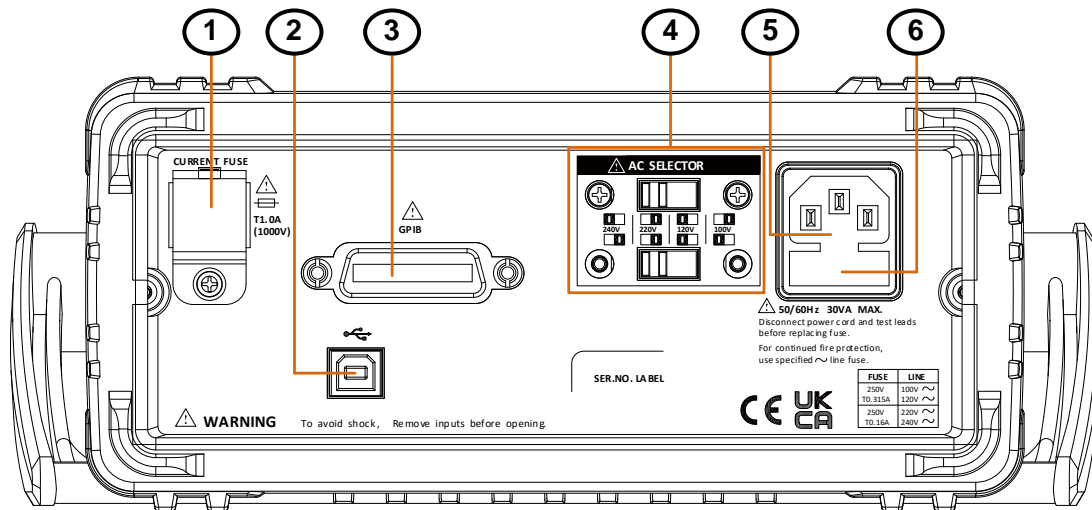

Item	Description
1	Current Fuse Box
2	USB Connector (B Type)
3	GPIB Connector (optional)
4	Alternate Input Switch
5	AC Mains Input (Power Cord Socket)
6	AC Mains Line Voltage Selector and Fuse Socket

Current Fuse Box

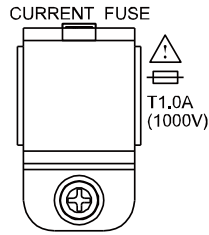

Holds the current fuse: T 1.0 A, 1000 V, 6*30 mm

For fuse replacement details, see page 150.

USB device port

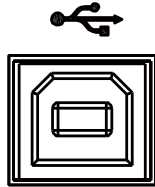

Accepts a USB device cable for remote control; Type B, female connector.

For remote control details, see page 108.

Optional GPIB port

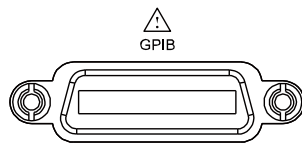

Accepts an optional GPIB card.

For GPIB details, see page 112.

Alternate Input Switch

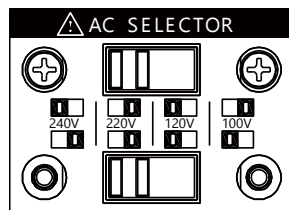

AC voltage selection:

100 V/120 V/220 V/240 V
±10 %, 50 Hz / 60 Hz

Power Cord Socket

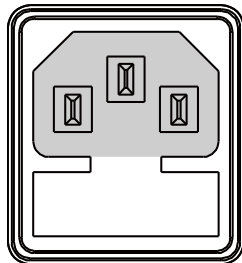

Accepts the power cord.

AC 100 V/120 V/220 V/240 V
±10 %, 50 Hz / 60 Hz ±10 %.

For power on sequence, see page 23.

Fuse Socket

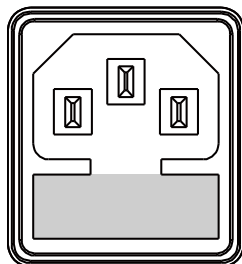

Holds the main fuse:

100 / 120 VAC: T 0.315 A

220 / 240 VAC: T 0.16 A

For fuse replacement details, see page 149.







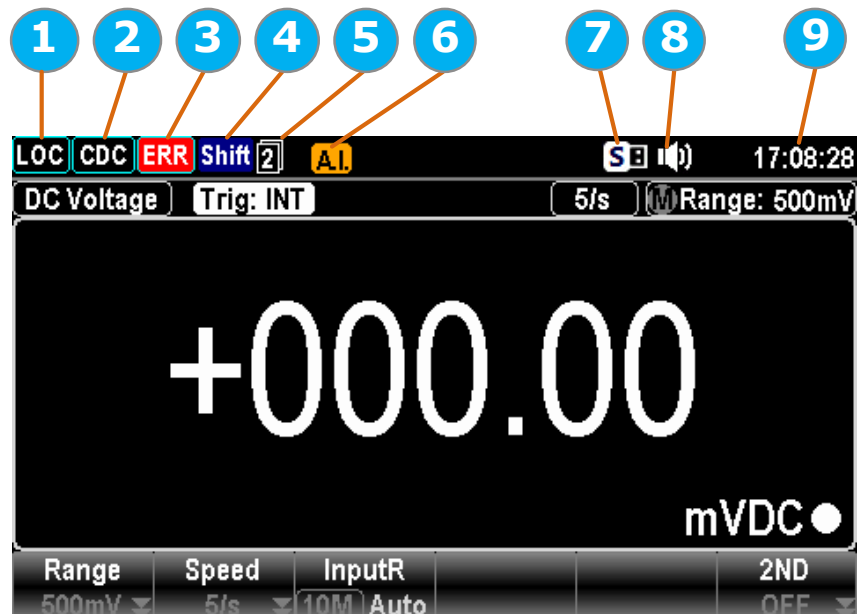



Status Bar







Background Identify each icon within the top status bar.

Status Bar
Display



Item	Description
1	Local/Remote control icon
2	USB-CDC/USB-TMC/GPIB interface icon
3	Error icon for commands from remote control
4	Shift key identification icon
5	The first and second function menu switch icon
6	Auto Identification for input source measurement
7	USB flash drive connection icon
8	Beep/Key Sound setting icon
9	Time display

Local Control		It indicates the unit is under local control mode.
Remote Control		It indicates the unit is under remote control. Refer to page 106 for details.
USB - CDC		It indicates USB - CDC interface is activated. Refer to page 111 for details.
USB - TMC		It indicates USB - TMC interface is activated. Refer to page 111 for details.
GPIB		It indicates GPIB interface is activated. Refer to page 112 for details.
ERROR		It indicates error occurs in commands. To erase the error icon, it is required to read or sweep the error by remote control commands or reboot action.
Shift		It indicates the shift key is being pressed ready for in conjunction with other keys for additional functions. Refer to page 15 for details.
First function menu		It indicates the active bottom menu corresponding to function keys is the first menu. Click the Enter key to switch to the second function menu.
Second function menu		It indicates the active bottom menu corresponding to functional keys is the second menu. Click the Enter key to switch to the first function menu.
A.I. (Automatic Identification)		It indicates the Auto Identification for measurement of different sources. Refer to page 51 for details.
Flash Drive – Capture		It indicates the Capture mode is ready for the connected flash drive. Refer to the page 100 for details of Capture.

Flash Drive – Save Reading		It indicates the Save Reading mode is ready for the connected flash drive. Refer to page 102 for details of Save Reading.
Flash Drive – Failure		It indicates something error occurs and thus flash drive fails to connect to unit.
Sound – Beep		It indicates sound of beep is enabled. Refer to page 91 for details.
Sound - Key		It indicates sound of key is enabled. Refer to page 92 for details.
Sound – All		It indicates sounds of beep and key are both enabled.
Sound – Off		It indicates sounds of beep and key are both disabled.
Time Display		It indicates the time display. For detailed setting, refer to page 94.

Set Up

Horizontal/Tilt/Vertical Applications

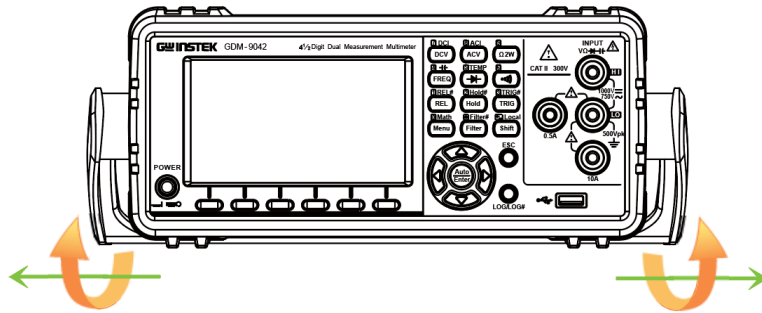

Pull out the handle sideways and rotate it clockwise for the applications below.

Horizontal

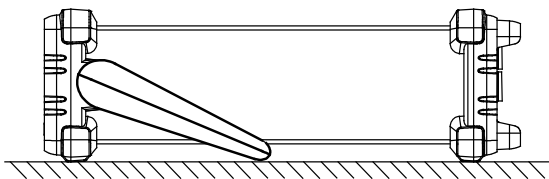

Place the unit horizontally.

Tilt

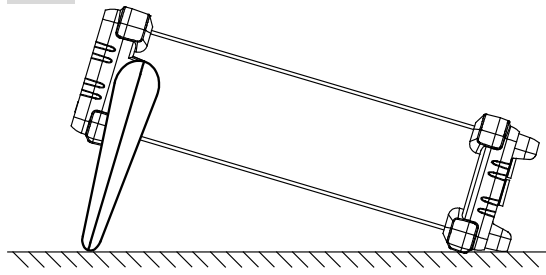

Rotate the handle for tilt stand.

Vertical

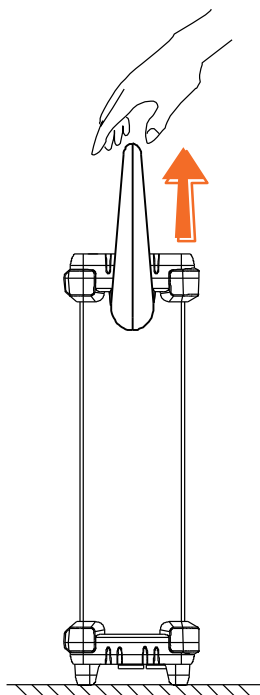

Place the handle vertically for hand carry.

Power Up

Steps

1. Before the power is turned on, confirm the input power supply meets the following conditions:
100 V/120 V/220 V/240 V
±10 %, 50/60 Hz

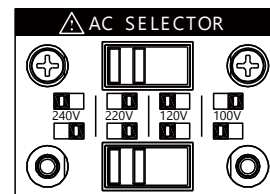

2. The fuse is a slow-blow fuse.
T 0.16 A (220 V/240 V),
T 0.315 A (100 V/120 V)

Confirm that the fuse is of the correct type and rating before connecting the power cord.

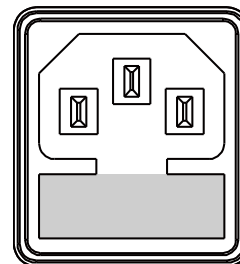

3. Connect the power cord to the the AC Voltage input.

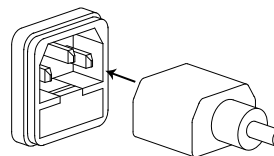

Note

Make sure the ground connector on the power cord is connected to a safety ground. This will affect the measurement accuracy.

4. Push the power button until click to turn on the main power switch on the front panel.

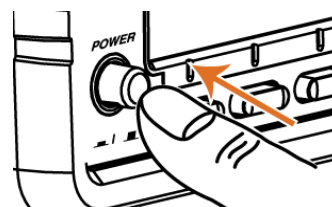

5. The screen firstly shows the logo brand of GWINSTEK followed by the message “Load the parameter [Last] is ok” indicating the last parameter is loaded in the initial startup.

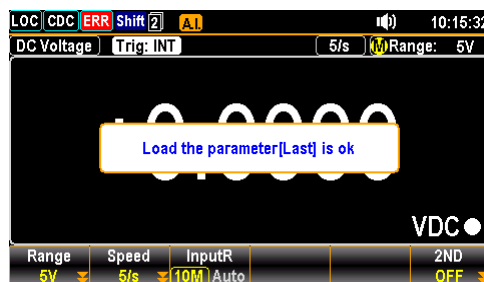

BASIC MEASUREMENT

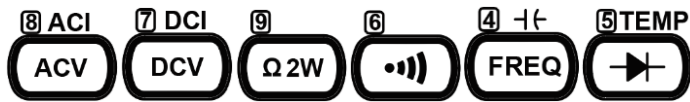

Basic Measurement Overview	26
Refresh Rate	26
Internal (Automatic) Triggering.....	28
AC/DC Voltage Measurement	29
Select Voltage Range	30
General Voltage Setting.....	31
Voltage Conversion Table	32
Crest Factor Table	33
AC/DC Current Measurement	34
Select Current Range.....	35
General Current Setting.....	36
2W Resistance Measurement	37
Select Resistance Range	38
General Resistance Setting	38
Continuity Test	39
Set Continuity Threshold	40
Diode Measurement	41
Frequency/Period Measurement	42
Frequency/Period In-Depth Setting	44
Capacitance Measurement	46
Cable Open Function	47
Select Capacitance Range	48
Temperature Measurement	49
General Temperature Setting	50

Thermocouple Sensor Type	50
Thermocouple Setting	50
A.I. (Auto Identification) Measurement.....	51

Basic Measurement Overview

Background Basic measurement refers to the several types of measurements assigned to the upper 2 row keys on the front panel.

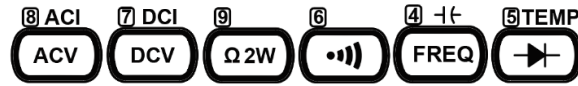

Measurement type	ACV	AC Voltage
	DCV	DC Voltage
	ACI	AC Current
	DCI	DC Current
	Ω 2W	2-wire Resistance
	••)	Continuity
	FREQ Hz	Frequency/Capacitance
	TEMP →)	Temperature/Diode

Advanced measurement Advanced measurement (page 60) mainly refers to the operation using the result obtained from one or more of the basic measurements.

Refresh Rate

Background Refresh rate defines how frequently the GDM-9041/9042 captures and updates measurement data. A faster refresh rate yields a lower accuracy and resolution. A slower refresh rate yields a higher accuracy and resolution. Consider these tradeoffs when selecting the refresh rate.

Measurement Type	Refresh Rate Available		
DCV/DCI/ 2W	5/s	40/s	160/s
ACV/ACI	5/s	40/s	160/s
Continuity / Diode	10/s	40/s	160/s
Frequency & Period	1s	100ms	10ms
Capacitance	2/s		
Temperature	5/s	40/s	160/s

Selection Procedure

Press the left or right Arrow keys to change the refresh rate.



Also, press the F2 (Speed) key to select a desired refresh rate. Press corresponding function key in accord with the desired option on display.

Speed



The refresh rate will be shown at the upper right corner of the display. See the example below.

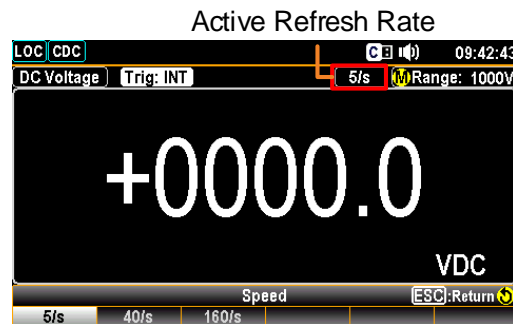

Note

The refresh rate cannot be set for capacitance measurement.

Reading indicator

The reading indicator , which is located in the lower-right corner of display, flashes according to the defined refresh rate setting.

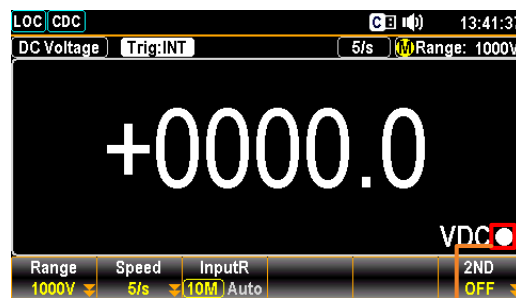

Reading Indicator

Internal (Automatic) Triggering

Overview By default, the GDM-9041/9042 automatically triggers measurement according to the set refresh rate. See the previous page for refresh rate setting details. The TRIG key, on the other hand, can be used to manually trigger once per click.

SIN (Manual) Trigger Simply press the TRIG key to SIN trigger mode, which signifies manual triggering measurement. Pressing once stands for trigger for single time.



Indicator SIN Trigger Mode

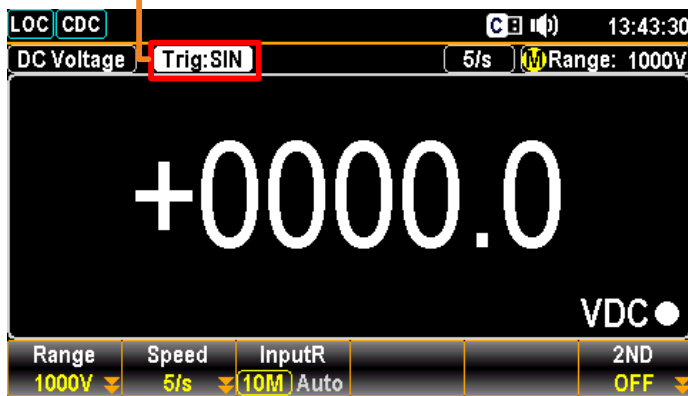

INT (Auto) Trigger Press and hold the TRIG key for 2 seconds to change to INT (Auto) trigger mode, which stands that automatic triggering measurement per refresh rate.

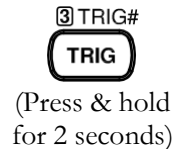

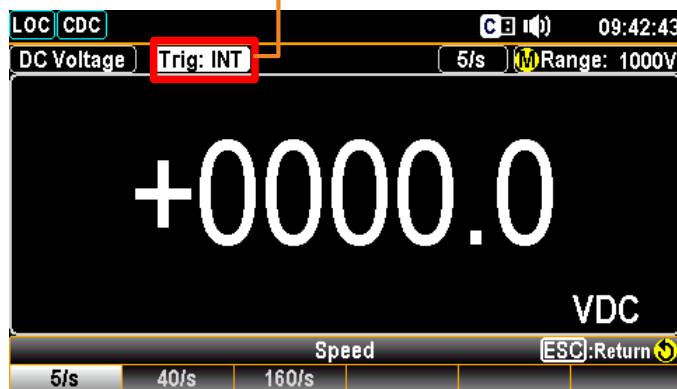

Indicator INT (Auto) Trigger Mode



Note SIN triggering is not supported for capacitance measurements.

AC/DC Voltage Measurement

Voltage type	AC	0 to 750V
	DC	0 to 1000V

Activate ACV/DCV	Press the ACV key or DCV key to measure AC or DC voltage, respectively.	 or 
------------------	---	--

ACV/DCV mode display appears The mode will switch to ACV, DCV mode immediately. See the figure below for example.

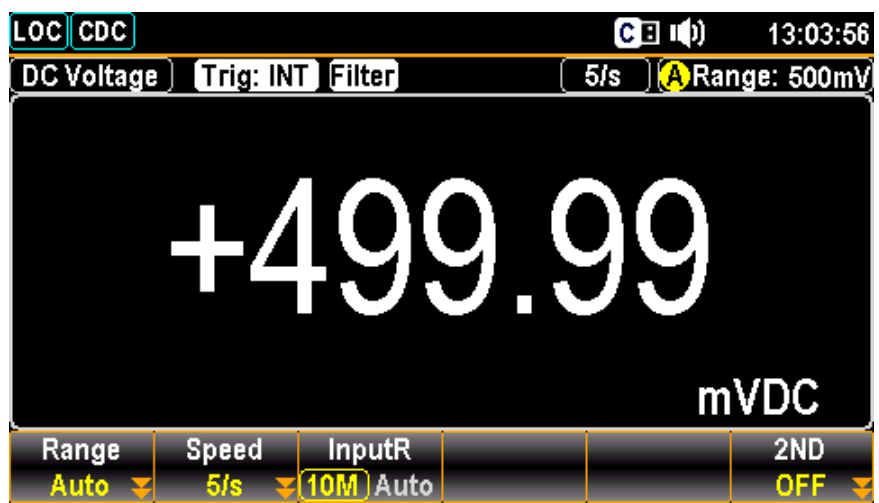

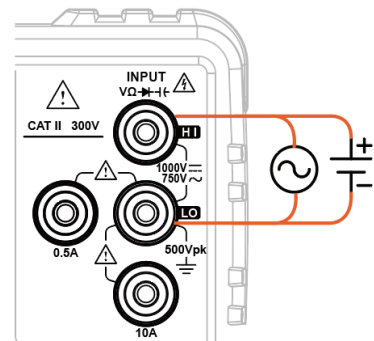

DC or AC Voltage	Indicates DC or AC Voltage mode
5/s	Indicates the active refresh rate
	Indicates Automatic range selection
Range: 500mV	Indicates the available range of Voltage
+499.99 mVDC	Indicates the exact measured value

Connect the test lead and measure Input HI and Input LO terminals. The display updates the reading.



Select Voltage Range

Auto range To turn the automatic range selection On/Off, press the Auto key. 

Manual range Press the up or down arrow key to select the range. The Auto indicator  turns to  indicating Manual range selection.

If the appropriate range is unknown, select the highest range.

You can also press the F1 (Range) key to select a desired range. 

Press the F1 to F6 key to select a desired range for the voltage measurement.



Selection list	Range	Resolution	Full scale
	500 mV	10 μ V	510.00 mV
	5 V	0.1 mV	5.1000 V
	50 V	1 mV	51.000 V
	500 V	10 mV	510.00 V
	750 V (AC)	100 mV	765.0 V
	1000 V (DC)	100 mV	1020.0 V

 **Note** For more detailed parameters, see the specifications on page 158.

General Voltage Setting

F2 (Speed) key
to select refresh
rate

DCV/ACV:

Press the F1 to F5 key to select the desired rate



Speed

F3 (Input R) key
to select input
resistance

Background Specify the input impedance to the test leads (Input R). This specifies the measurement terminal input impedance, which is either Auto or 10 MΩ.

Input R
10M Auto

The Auto mode selects high impedance (Hi-Z) for the 500 mV, 5 V ranges, and 10 MΩ for the 50 V and 500 V and 1000 V ranges. In most situations, 10 MΩ is high enough to not load most circuits, but low enough to make readings stable for high impedance circuits. It also leads to readings with less noise than the (Hi-Z) option, which is included for situations where the 10 MΩ load is significant.

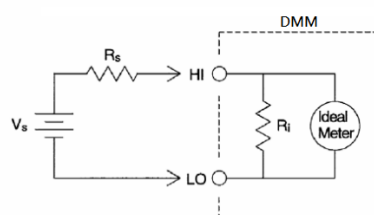

V_s = ideal voltage of DUT





R_s = input impedance of DUT

R_i = input impedance of
GDM-9041/9042 (either 10 M or 10
G available (Hi-Z))

Deviation (%) = $R_s / (R_s + R_i) * 100$

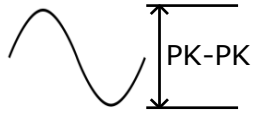
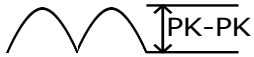

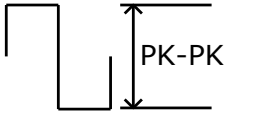

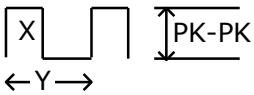
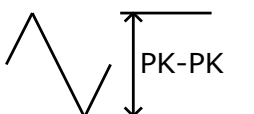
Voltage Conversion Table

Background This table shows the relationship between AC and DC reading in various waveforms.

Waveform	Peak to Peak	AC (True RMS)	DC
Sine 	2.828	1.000	0.000
Rectified Sine (full wave) 	1.414	0.435	0.900
Rectified Sine (half wave) 	2.000	0.771	0.636
Square 	2.000	1.000	0.000
Rectified Square 	1.414	0.707	0.707
Rectangular Pulse 	2.000	$2K$ $K = \sqrt{(D - D^2)}$ $D = X/Y$	$2D$ $D = X/Y$
Triangle Sawtooth 	3.464	1.000	0.000

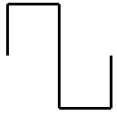
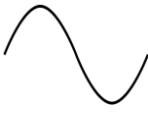
Crest Factor Table

Background Crest factor is the ratio of the peak signal amplitude to the RMS value of the signal. It determines the accuracy of AC measurement. If the crest factor is less than 3.0, voltage measurement will not result in error due to dynamic range limitations at full scale. If the crest factor is more than 3.0, it usually indicates an abnormal waveform as seen from the below table.

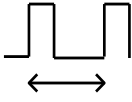
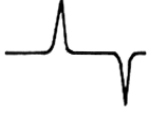
Waveform	Shape	Crest factor
Square wave		1.0
Sine wave		1.414
Triangle sawtooth		1.732
Mixed frequencies		1.414 to 2.0
SCR output 100% to 10%		1.414 to 3.0
White noise		3.0 to 4.0
AC Coupled pulse train		>3.0
Spike		>9.0

AC/DC Current Measurement

Background The GDM-9041/9042 series DMMs have two input terminals for current measurement. A 0.5A terminal for current less than 0.5A and a 10A terminal for measurements up to 12A. The units can measure 0 to 10A for both AC and DC current.

Current type AC/DC 0.5A/10A

Activate ACI/ DCI Measure Press the Shift → ACV or Shift → DCV key to measure AC or DC current, respectively.

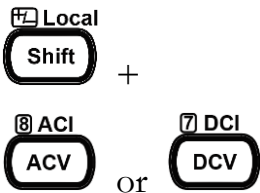

ACI/DCI mode display appears The measurement will switch to ACI, DCI mode immediately. See the figure below for example.

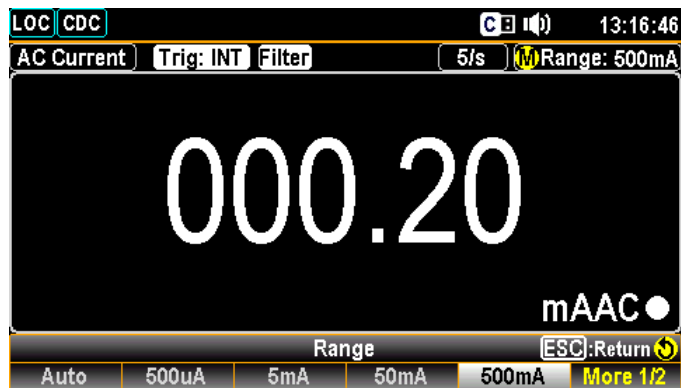

AC or DC Current	Indicates DC or AC Current mode
5/s	Indicates the active refresh rate
	Indicates Automatic range selection
Range: 500mA	Indicates the available range of Current
000.20 mAAC	Indicates the exact measured value

Connect the test lead and measure

Connect the test lead between the 10 A terminal and the COM terminal or DC/AC 0.5 A terminal and the COM terminal, depending on the input current.

For current ≤ 0.5 A use the 0.5 A terminal; For current up to 12 A use the 10 A terminal. The display updates the reading.

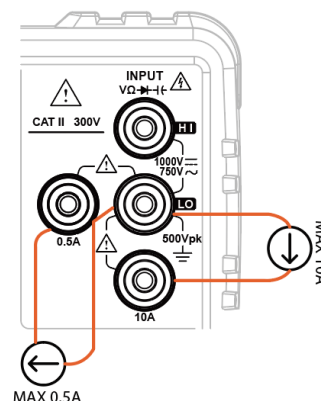

Select Current Range

Auto range

To turn the automatic range selection On/Off, press the AUTO key. The most appropriate range for the currently used input jack will be automatically selected. The GDM-9041/9042 is able to do this by remembering the last manually selected range and using that information to determine the smallest current range that the auto-range function will switch to. When the current input is switched to another terminal, the range must be manually set.



⚠ Auto Range not allowed on 10A

Manual range

Press the up or down arrow key to select the range. The AUTO indicator **A** turns to **M** indicating Manual range selection.



If the appropriate range is unknown, select the highest range.

You can also press F1 (Range) key to select a range for the measurement.



Press the F1 to F5 key to select a desired range for the measurement.



Press the F6 (More 1/2) key for next page with more options as the figure shown below.



Selectable Current Ranges	Range	Resolution	Full scale	INJACK
	500 μ A	10 nA	510.00 μ A	0.5 A
	5 mA	100 nA	5.1000 mA	0.5 A
	50 mA	1 μ A	51.000 mA	0.5 A
	500 mA	10 μ A	510.00 mA	0.5 A
	5 A	100 μ A	5.1000 A	10 A
	10 A	1 mA	12.000 A	10 A

 **Note** For further details, see the specifications on page 158.

General Current Setting

F2 (Speed) key to select the rate

DCI/ACI:

Press the F1 to F5 key to select the desired rate



2W Resistance Measurement

Measurement type 2-wire OHM Uses the standard Input HI-LO terminals.

Activate 2W Measurement Press the Ω 2W key to activate 2W resistance measurement.



2W resistance mode display appears

The mode will switch to the selected resistance mode immediately. Press the Shift → Ω 2W key on the front panel as figure shown below.

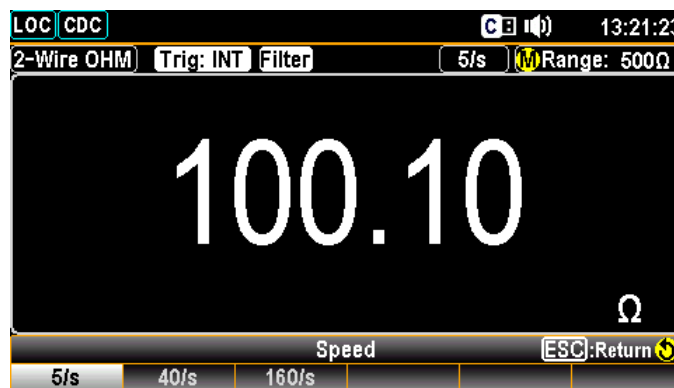

2-Wire OHM Indicates 2W Resistance mode

5/s Indicates the active refresh rate



Indicates Automatic range selection

Range: 500 Ω Indicates the available range of Resistance



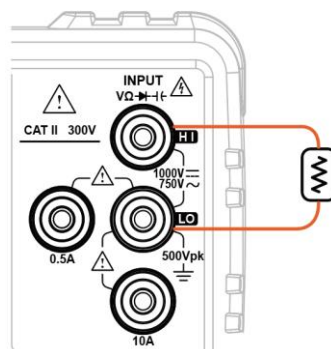

100.10 Ω Indicates the exact measured value

Connect the test lead and measure For 2W measurement, connect the test leads between the Input HI terminal and the LO terminal.



Select Resistance Range

Auto range To turn the automatic range selection On/Off, press the Auto key. 

Manual range Press the up or down arrow key to select the range. The Auto indicator  turns to  indicating Manual range selection. If the appropriate range is unknown, select the highest range. 

You can also press the F1 (Range) key to select a range for the measurement. 

Press the F1 to F5 key to select a desired range for the measurement.



The screenshot shows a menu titled "Range" with options: Auto, 500Ω, 5kΩ, 50kΩ, 500kΩ, and More 1/2. The "More 1/2" option is highlighted in yellow. The menu also shows "ESC:Return" and a right arrow icon.

Press the F6 (More 1/2) key for next page with more options as the figure shown below. 



The screenshot shows a menu titled "Range" with options: 5MΩ, 100MΩ, and Page Up. The "Page Up" option is highlighted in yellow. The menu also shows "ESC:Return" and a right arrow icon.

Selectable Resistance Ranges	Range		
	Range	Resolution	Full scale
	500 Ω	10 mΩ	510.00 Ω
	5 kΩ	100 mΩ	5.1000 kΩ
	50 kΩ	1 Ω	51.000 kΩ
	500 kΩ	10 Ω	510.00 kΩ
	5 MΩ	100 Ω	5.1000 MΩ
	100 MΩ	10 kΩ	120.00 MΩ

Note For more details, see the specifications on page 158.

General Resistance Setting



F2 (Speed) key to select the rate Press the F1 to F5 key to select the desired rate 



The screenshot shows a menu titled "Speed" with options: 5/s, 40/s, 160/s, and Page Up. The "Page Up" option is highlighted in yellow. The menu also shows "ESC:Return" and a right arrow icon.

Continuity Test

Background The continuity test checks that the resistance in the DUT is low enough to be considered continuous (of a conductive nature).

Activate continuity test Press the  key to activate continuity testing. 

Continuity mode display appears The mode will switch to continuity testing immediately. Press  on the front panel as figure shown below.

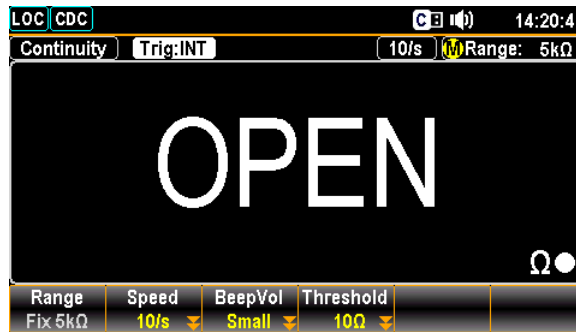

Continuity	Indicates Continuity measurement
10/s	Indicates the active refresh rate
	Indicates Manual range selection
5kΩ	Indicates the available range of Continuity ⚠ Note: the range selection is fixed in 5kΩ
OPEN Ω	Indicates the currently measured result

Connect the test lead and measure Connect the test lead between the Input HI terminal and the LO terminal. The display updates the reading.

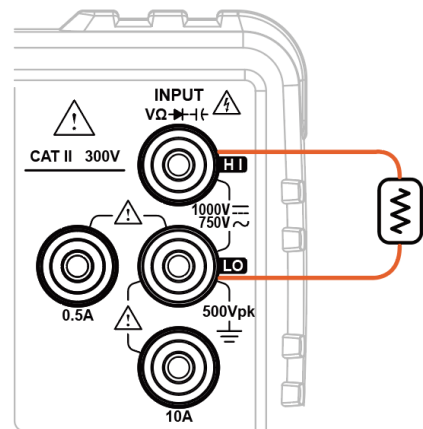

F2 (Speed) key to select the rate. Press the F1 to F3 key to select the desired rate



F3 (BeepVol) key to select the Vol Press the F2 to F4 key to select the volume level or press the F1 key to set Beep volume off



Set Continuity Threshold

Background The continuity threshold defines the maximum resistance allowed in the DUT when testing the continuity.

Threshold Range Threshold 1 to 1000 Ω (Default Threshold:10 Ω)
Resolution 1 Ω

Procedure Press the F4 key to enter the Threshold of Continuity menu as the figure below shown.



Set the continuity threshold level.

1. Use the Arrow keys or press Number keys to designate a desired value.
2. Press the Enter key to confirm the set value for threshold setting.

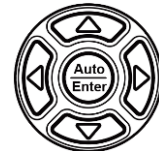



Display





Diode Measurement

Background The diode test checks the forward bias characteristics of a diode by running a constant forward bias current of approximately 1 mA through the DUT.

Activate diode test Press the  key to activate diode measurement. 

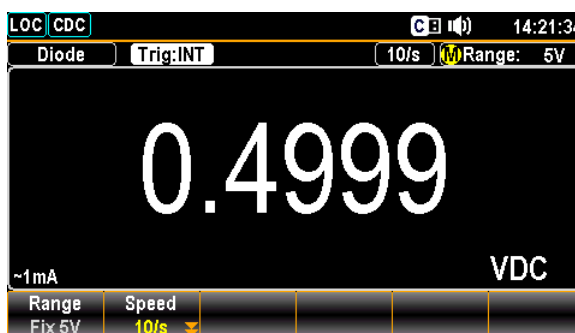
Diode mode display appears The screen will switch to Diode mode immediately as the figure shown below.



- Diode Indicates the Diode measurement
- 10/s Indicates the active refresh rate
-  Indicates Manual range selection
- 5V Indicates the available range of Diode
⚠ Note: the range selection is fixed in 5V
- 0.4999 VDC Indicates the exact measured value

Connect the test lead and measure Connect the test lead between the Input HI terminal and the LO terminal; Anode-V, Cathode-COM. The display updates the reading.

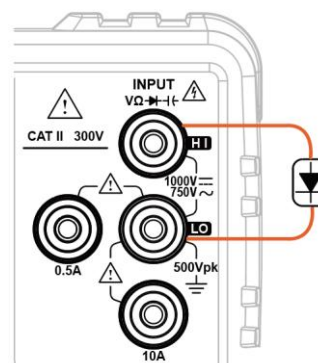

F2 (Speed) key to select the rate. Press the F1 to F3 key to select the desired rate



Frequency/Period Measurement

Description The GDM-9041/9042 can be used to measure the frequency or period of an input signal.

Range	Frequency	10 Hz to 1 MHz
	Period	1.0 μ s to 100 ms

Activate frequency or period test

- To measure Frequency, press the **FREQ** key followed by clicking the **F3 (Measure)** key to enter the Measure menu. Click the **F1 (Frequency)** key and the measured frequency will be displayed on the primary screen with the period value displayed on the sub section beneath.



- To measure Period, press the **FREQ** key followed by clicking the **F3 (Measure)** key to enter the Measure menu. Click the **F2 (Period)** key and the measured period will be displayed on the primary screen with the frequency value displayed on the sub section beneath.



Display Frequency Mode

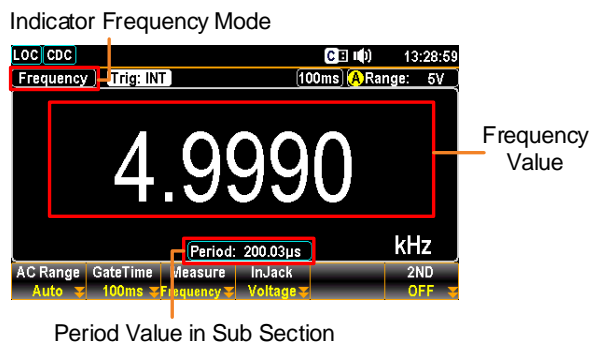

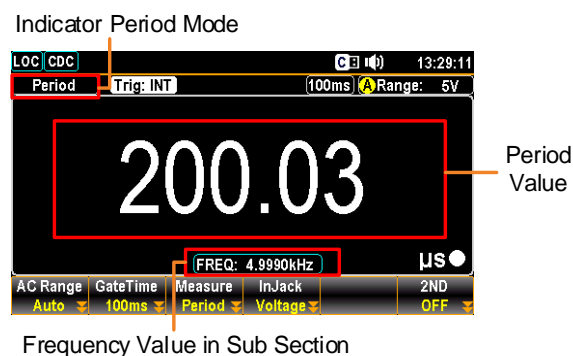

Period Mode

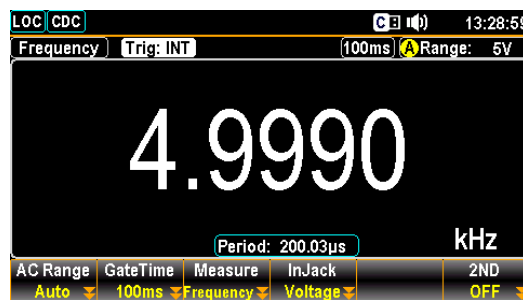

Frequency mode display appears

The mode will switch to the Frequency or Period mode immediately. Press  on the front panel followed by clicking F3 key to choose Frequency as shown below.



Frequency	Indicates Frequency measurement
100ms	Indicates the active refresh rate
	Indicates Manual range selection
5V	Indicates the available range of Voltage
4.9990 Hz	Indicates the exactly measured Frequency value
200.03 µs	Indicates the exactly measured Period value

Connection

Depending on different inputs, connect test lead to varied terminals. In terms of voltage, connect test leads between the Input HI terminal and the LO terminal. The display updates the reading.

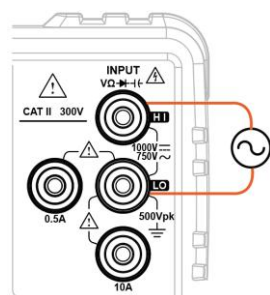

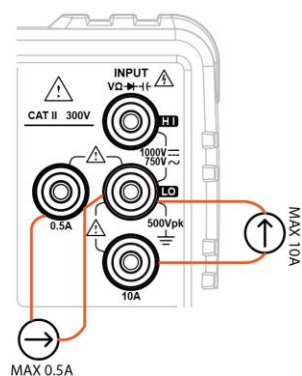

In terms of current, connect test leads between the 0.5 A terminal and the LO terminal or DC/AC 10 A terminal and the LO terminal. The display updates the reading.



Frequency/Period In-Depth Setting

Background The input voltage/current range for frequency/period measurements can be set to Auto range or to manual. By default, the voltage/current range is set to Auto for both the period and frequency.

Auto range Press the Auto key. Auto  will be displayed on the upper right corner. 

F2 (Gate Time) key to select gate time **Background** It is the threshold to recalculate frequency/period. Slower the gate time, e.g., 1s, more accurate the reading value.

Press the F2 key to enter gate time menu. Click the F1 – F3 key for the desired gate time. See the figure below with available options. 



F4 (InJack) key to select voltage or current **Background** In accordance with the target inputs, choose the corresponding selection per condition. E.g., select “0.5 A” when the input current is below 0.5 A amplitude.

Press the F4 (InJack) key to determine whether the voltage or current 0.5 A or current 10 A to be measured. Press the F1 – F3 key to select desired option. See the figure shown below with options available. 



F1 (AC Range) key to manually select range setting

Press the up or down arrow key to select desired range. The Auto indicator **A** turns to **M** indicating Manual range selection. If the appropriate range is unknown, select the highest range.

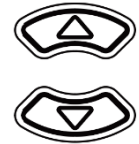

You can also press the F1 (AC Range) key to select a range for the measurement. Depending on the InJack setting, the available options vary. See examples below.

AC Range

When InJack is Voltage:

Press the F1 to F6 key to select a desired range for the measurement.



When InJack is 0.5A:

Press the F1 to F5 key to select a desired range for the measurement.





When InJack is 10A:



Press the F1 to F3 key to select a desired parameter for the measurement.



Capacitance Measurement

Background The capacitance measurement function checks the capacitance of a component.

Activate capacitance test Press the Shift → **FREQ** to activate capacitance measurement.  + 

Capacitance mode display appears The screen will switch to capacitance mode immediately. Press  +  on the front panel as shown below.

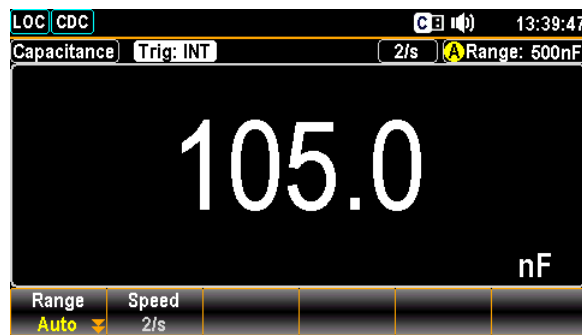

- Capacitance Indicates the Capacitance measurement

- 2/s Indicates the active refresh rate
 Note: refresh rate of Capacitance is fixed in 2/s.

-  Indicates Automatic range selection

- Range: 500nF Indicates the available range of Capacitance

- 105.0 nF Indicates the exact measured value

Connect the test lead and measure Connect the test lead between the Input HI terminal and the LO terminal; Positive-HI, Negative-LO. The display updates the reading.

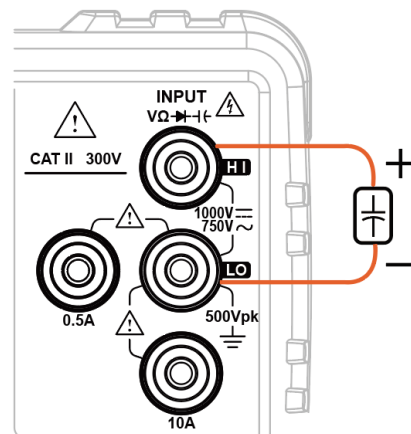

Cable Open Function

Background

Cable open function will be activated when capacitance range is between 5 nF and 50 nF. It is required to proceed to Cable Open function when capacitance is between 5 nF and 50 nF in which test leads connected will result in measuring capacity in small scale.

Display

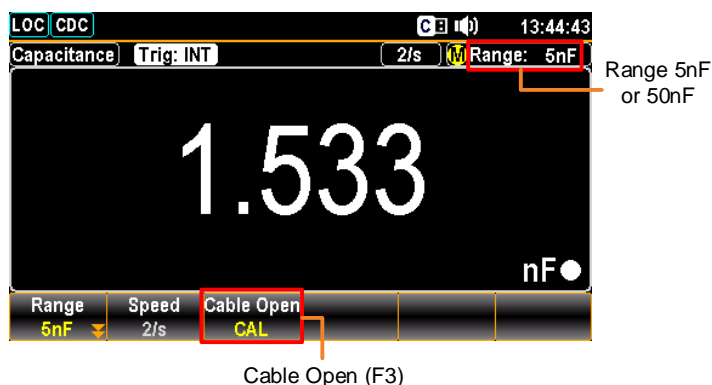

Activate cable open function

Connect test leads followed by pressing the F3 (Cable Open) key to proceed to Cable Open function. The measured value will be rectified and returned to zero as the figure shown below.

Cable Open
CAL

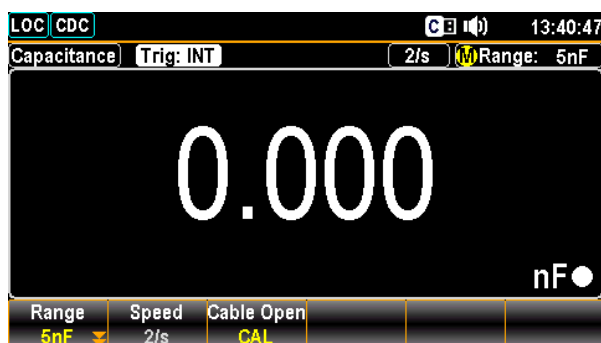

Connect the test lead and measure





Follow the connection method of capacitance measurement to measure and obtain precise-prone value.

! Note

Except for 5 nF/50 nF, all are Not applicable to Cable Open function.

Select Capacitance Range

Auto range To turn the automatic range selection On/Off, press the Auto key. 

Manual range Press the up or down arrow key to select desired range. The Auto indicator  turns to  indicating Manual range selection. If the appropriate range is unknown, select the highest range. 



You can also press the F1 (Range) key to select a  range for the measurement.

Press the F1 to F5 key to select a desired range for the measurement.



Selectable Capacitance Ranges	Range		
	Range	Resolution	Full scale
	5 nF	1 pF	5.100 nF
	50 nF	10 pF	51.00 nF
	500 nF	100 pF	510.0 nF
	5 µF	1 nF	5.100 µF
	50 µF	10 nF	51.00 µF



 **Note** For further details, please see the specifications on page 158.

 **Note** The refresh rate settings cannot be used in the capacitance mode.

Temperature Measurement

Background The GDM-9042 can measure temperature utilizing Thermocouple devices. To measure temperature, the GDM-9042 accepts a device input and calculates the temperature from the voltage fluctuation. Temperature measurement is only supported on the GDM-9042.

Temperature Range Thermocouple -200 °C to +300 °C (vary by sensor types)

Activate temperature measurement Press the Shift +  key to activate temperature measurement.  + 

Temperature mode display appears

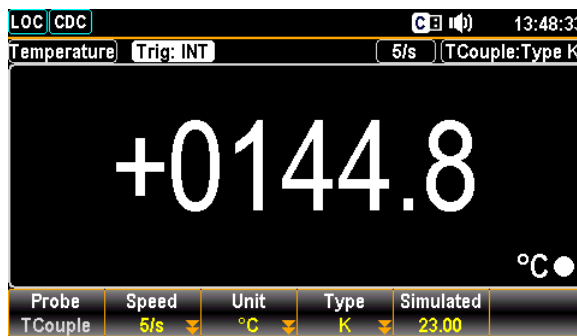

Temperature	Indicates Temperature measurement
+0144.8 °C	Indicates the exact measured value
TCouple	Indicates the active Probe
Type K	Indicates the active Type

Connect the test lead and measure

Connect the sensor lead between the Input HI terminal and the LO terminal. The display updates the reading.

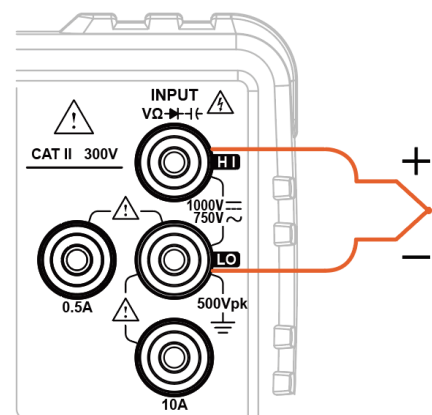

General Temperature Setting

F2 (Speed) key to select the rate Press the F1 to F3 key to select the desired rate **Speed**



F3 (Unit) key to select unit of temperature Press the F4 (Unit) key to enter the Temperature Unit menu followed by clicking the F1 – F2 key to choose desired temperature unit. See the figure shown below. **Unit**



Thermocouple Sensor Type

Background The GDM-9042 accepts thermocouple inputs and calculates the temperature from the voltage difference of two dissimilar metals. Thermocouple sensor type is one of the main factors to be considered.

Parameter	Thermocouple Sensor Type	Measurement Range	Resolution
	J	-200 to +300 °C	0.1 °C
	K	-200 to +300 °C	0.1 °C
	T	-200 to +300 °C	0.1 °C

Thermocouple Setting

Procedure 1. Press the F4 (Type) key **Type** to enter the Sensor Type menu as the figure shown below. Click the F1 – F3 key to select a desired sensor type per situations.



2. Further press the F5 (Simulated) key **Simulated** after returning to the previous menu page. You can input a desired parameter as the following figure (+23 for example) for the so-called “Reference Junction Temperature”.



3. Press the Enter key  to confirm the setting.

A.I. (Auto Identification) Measurement

Background The GDM-9041/9042 can identifying the connected sources and switches to the corresponding measurements automatically, which allows user to operate the unit in a more friendly manner with ease.

Applicable measurement	ACV	DCV	2W	Diode	Continuity
	●	●	●	●	●

- Step**
1. Press and hold the physical Enter key for 2 seconds to activate the A.I. function. The icon of A.I., which appears in orange background signifying auto identification is underway, on the upper status bar pops up accordingly.



(Press & hold for 2 seconds)

The A.I. function is identifying source

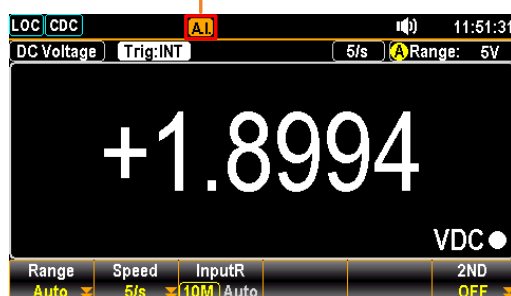

2. After the auto identification is finished, the A.I. icon becomes in green background, which represents that the A.I. function is in Standby mode and ready for next identifying of connected source.

The A.I. function is in Standby mode

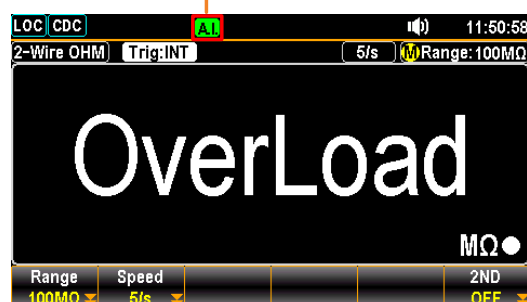

DUAL MEASUREMENT



Dual Measurement	53
Refresh Rate	56
Connect the Test Leads	57
The error influence on Dual Measurement (V & I)	59
The error of current shunt	60

Dual Measurement

Background

The dual measurement mode allows you to use the 2nd display to show another item, thus viewing two different measurement results at once.

When the multimeter is used in dual measurement mode, both displays are updated from either a single measurement or from two separate measurements. If the primary and secondary measurement modes have the same range, rate and rely on the same fundamental measurement, then a single measurement is taken for both displays; such as ACV and frequency/period measurements. If the primary and secondary displays use different measurement functions, ranges or rates, then separate measurements will be taken for each display. For example, ACV and DCV measurements.

Most of the basic measurement functions, except for resistance/continuity/diode/capacitance can be used in the dual measurement mode.

The following table shows the available measurement combinations.

Primary Display	Secondary Display					
	ACV	DCV	ACI	DCI	FREQ	2W
ACV	●	●	●	●	●	X
DCV	●	●	●	●	X	X
ACI	●	●	●	●	●	X
DCI	●	●	●	●	X	X
FREQ	●	X	●	X	●	X
2W	X	X	X	X	X	●

Note

When two different measurements are taken, there is a switching delay between the first measurement and the second measurement.

1st Measurement item setting

Choose one of the basic measurement functions from the table above to set the measurement mode for the primary display.



For example, press DCV to set the first display to DCV measurement.

2nd Measurement item setting

To set a measurement mode for the second display, press the F6 (2ND) key and the 2ND Function options appear subsequently.



For example, press the F3 (ACV) key to select ACV measurement for the second display.

Display

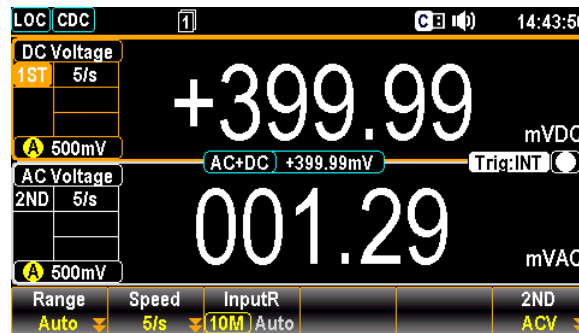

1ST Display Shows the DCV measurement

2ND Display Shows the ACV measurement





1ST in orange Indicates that 1ST display is the currently active display.

Editing 1st or 2nd measurement item settings

After the secondary measurement function has been activated, the rate, range and measurement item can be edited for either the primary or secondary display.

Note, however, it is more practical to configure the first or second measurement items before activating dual measurement mode.

To edit measurement parameters in dual measurement mode, you must first set which display is the active display. The orange outline covering either 1ST or 2ND icon indicates the active display.

1. Select active display	<p>Toggle the active display between the 1ST and 2ND display by long pressing the Shift key for 2 seconds:</p> <p>Primary display: 1ST highlighted in orange outline.</p> <p>Secondary display: 2ND highlighted in orange outline.</p>	 (Press & hold for 2 seconds)
Display	<p>1ST in active display: </p> <p>2ND in active display: </p>	
2. Edit active display settings	<p>Edit the range, rate or measurement item for the active display in the same way as for single measurement operation. See the Basic Measurement on page 24 for details.</p>	
Turn Off 2nd Measurement	<p>To turn Off the 2ND measurement, first toggle in 1ST active display followed by pressing the F6 (2ND) key. Click the F6 (OFF) key again to disable the 2ND measurement.</p>	

Refresh Rate

Background Refresh rate defines how frequently the GDM-9041/9042 captures and updates measurement data. A faster refresh rate yields a lower accuracy and resolution. A slower refresh rate yields a higher accuracy and resolution. Consider these tradeoffs when selecting the refresh rate.

Measurement Type	Refresh Rate		
DCV/DCI	5/s	40/s	160/s
ACV/ACI	5/s	40/s	160/s
Frequency/Period	1s	100ms	10ms

Selection steps 1. Toggle the active display between the 1ST and 2ND display by pressing the Enter key until click.



2. Press the F2 (Speed) key to select a desired rate for measurement. Press the corresponding function key (F1 – F5) in accord with the desired option on screen display. Also, press the F6 (More 1/2) key to enter the next page with more options when available.



3. The refresh rate will be shown at the left side of each display. See the figure below shown.

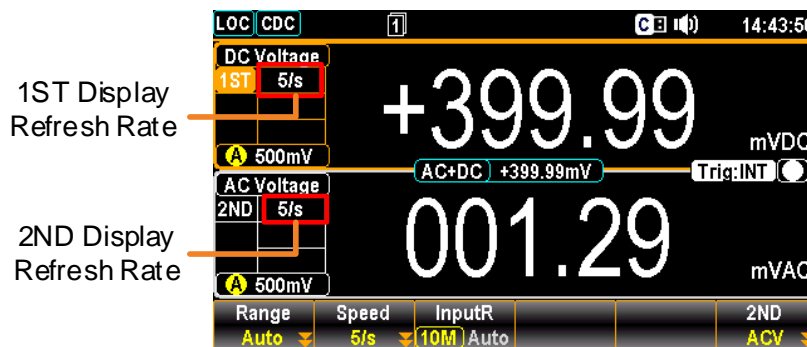

Reading Indicator

The reading indicator  flashes according to the defined refresh rate setting of the active display.

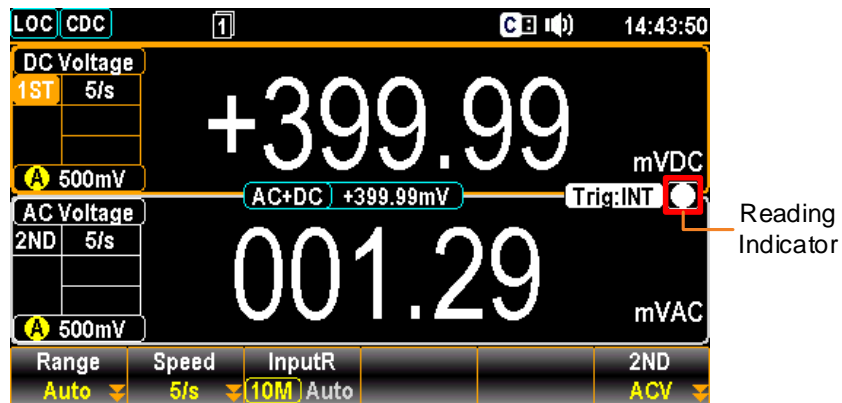

Connect the Test Leads

Connect the test leads and measure

When using the dual measurement function, the connection method and number of test leads required depends on the measurement combination. Use the connect diagrams below as guide when taking dual measurements.

Voltage and Frequency/Period Measurement

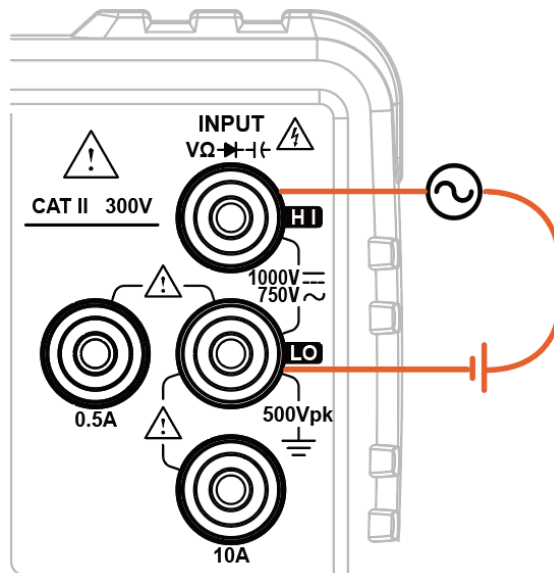

Voltage/Frequency/
Period and Current
Measurement

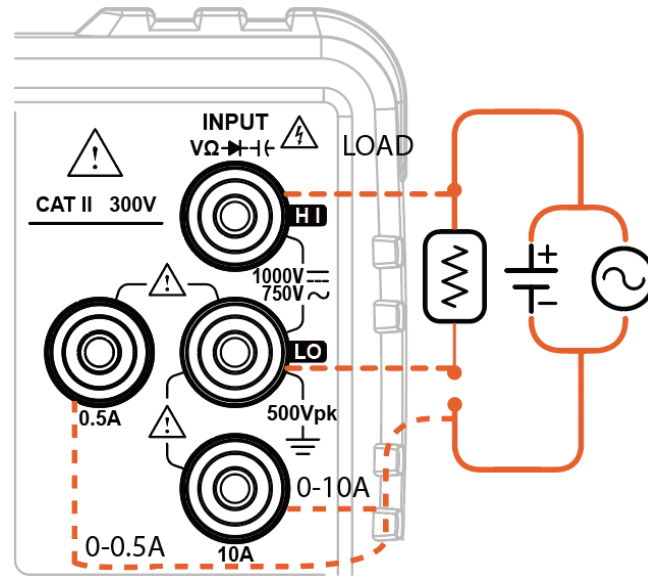

 Note

DC Current measurements will be displayed as a negative value as the polarity of the current leads has been reversed.

Please take into account the resistance of the test leads and internal resistance of the current connection as it is in series with the test circuit.

The above measuring configuration is used to measure the voltage present on the resistance under test and the current through the resistance under test when using the DCI/DCV or ACI/ACV dual measurement function.

When dual measurement (DCI/DCV or ACI/ACV) is underway, the input impedance will change, thus resulting in load deviation due to the fluctuation of different measuring range.

The error influence on Dual Measurement (V & I)

Background

While dual measurement of voltage and current is being executed, the route from DMM internal circuit to the LO terminal circuit for measuring voltage is totally identical with that for measuring current, and thus the resistor within the route is commonly shared by the two measuring circuits. While measuring current, the resistor within the circuit will generate a voltage drop. When the internal resistor of LO terminal is added to the external load resistor within the circuit, the accuracy of voltage reading will be influenced.

Diagram

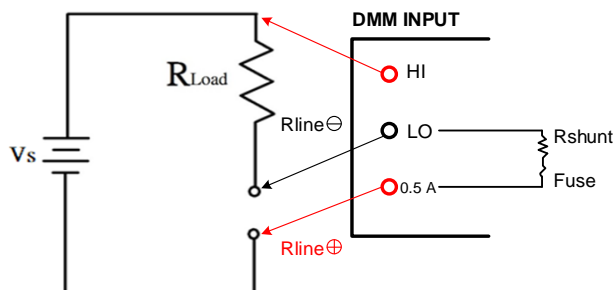

Example

V_s = Voltage source

R_{Load} = Load under test

R_{int} = Current terminal total impedance containing $R_{shunt} + Fuse + R_{line\oplus} + R_{line\ominus}$

When different current range for measurement is selected, R_{shunt} will vary accordingly.

For example,

$V_s = 10\text{ V}$, $R_{Load} = 10\ \Omega$, $V_s = 10\text{ V}$, $R_{Load} = 10\ \Omega$

If the total impedance passing through current terminal is $R_{int} = 0.5\ \Omega$, the ideal measured voltage will be 10V regardless of impact on load from voltmeter input impedance. The calculation for actual measured

$$\text{value is } 10\text{V} * \frac{10\ \Omega}{(10\ \Omega + 0.5\ \Omega)} = 9.523\text{ V.}$$

$$\text{Error (\%)} = \frac{R_{int}}{(R_{Load} + R_{int})} * 100$$
, this error is applicable to not only DC but AC measurement as well. The influence will be probably more serious depending on varied actual conditions.

The error of current shunt

Background

The principle of current measuring is to obtain current via the voltage proportionated by the measured shunt resistor and the current under test. The circuit is basically designed by high impedance (0.01Ω to 100Ω approximately) and with shortcoming of voltage drop by shunt. There will be obvious error occurred while measuring low current due to the measurable voltage generated by a larger shunt.

An ideal ammeter never changes flowing route of current, and thus it owns the characteristics of both zero-input resistor and zero-input voltage drop. In practice, however, ammeter always generates an input voltage drop while measuring, which is known as burden voltage in series.

Diagram

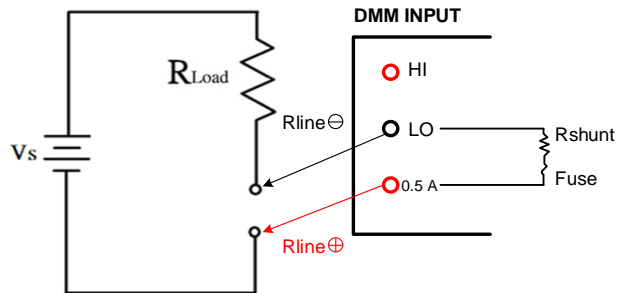

Example

V_s = Voltage source

R_{Load} = Load under test

R_{int} = Current terminal total impedance containing
 $R_{shunt} + Fuse + R_{line}^{\oplus} + R_{line}^{\ominus}$

When different current range for measurement is selected, R_{shunt} will vary accordingly.

For example,

$V_s = 10\text{ V}$, $R_{load} = 10\ \Omega$, $R_{int} =$ total impedance flowing through current terminal $0.5\ \Omega$

The theoretical value for current reading should be

$$I = \frac{V_s}{R_{load}} = 1\text{ A}$$
 in that the DMM internal resistor R_{int} , which contains Shunt, R_{line}^{\oplus} , R_{line}^{\ominus} and Fuse, will cause impact on the measuring reading.

The measured value is
$$I = \frac{V_s}{(R_{load} + R_{int})} = \frac{10\text{V}}{(10\Omega + 0.5\Omega)} = 0.9523\text{ A}.$$

$$\text{Error (\%)} = \frac{R_{int}}{(R_{load} + R_{int})} * 100$$

This error is applicable to not only DC but AC measurement, and the burden voltage, per varied current measuring range, is generally within the range of several hundreds mV.

	Range	Shunt	Burden Voltage
DC Current	500 μA	100 Ω	0.06 V Max.
	5 mA	100 Ω	0.6 V Max.
	50 mA	1 Ω	0.14 V Max.
	500 mA	0.1 R	1.41 V Max.
	5 A	10 m Ω	0.5 V Max.
	10 A	10 m Ω	0.8 V Max.

The above table indicates the maximum burden voltage caused by the maximum current within the applicable range.

A DVANCED MEASUREMENT



Advanced Measurement Overview	63
Relative Value Measurement.....	64
Hold Measurement	66
Trigger Setting	68
Automatic/Single Triggering	68
Filter Setting	69
Digital Filter Overview.....	69
Digital Filter Setting	71
Math Measurement	72
dBm/dB/Watt Measurement	72
Compare Mode	79
MX+B Measurement.....	82
1/X Measurement	84
Measure Percent.....	86

Advanced Measurement Overview

Background Advanced measurement mainly refers to the type of measurement which uses the result obtained by one of the basic measurements: ACV, DCV, ACI, DCI, 2W, Diode/Continuity, Frequency/Period, and Temperature.

Advanced Measurement	Basic Measurement						
	AC/DCV	AC/DCI	2W	Hz/P	TEMP*	→+/(•))	+←
Relative	●	●	●	●	●	—	—
Hold	●	●	●	●	●	—	—
Trigger	●	●	●	●	●	●	—
Filter	●	●	●	●	●	—	—
dB	●	—	—	—	—	—	—
dBm	●	—	—	—	—	—	—
Compare	●	●	●	●	●	—	●
MX+B	●	●	●	●	●	—	—
1/X	●	●	●	●	●	—	—
Percent	●	●	●	●	●	—	—



*Temperature measurement is not supported by the GDM-9041.

Relative Value Measurement

Applicable to 8 ACI 7 DCI 9 Ω2W 4 ±f 5 TEMP
ACV DCV Ω2W FREQ →←

Background Relative measurement stores a value, typically the data at the moment, as the reference. The following measurement is shown as the delta between the references. The reference value will be cleared upon exit.

REL, basically, is to subtract a certain value in the following measurement. The value is fixed and remains its effect even user exits and returns back to this function again.

One of the most seen purposes of REL is to eliminate impedance of test lead from measurement. Before operating impedance measurement, short circuit the test lead followed by pressing the [REL] button. For other measurements, press the [REL] button after putting test lead in a null circuit.

Alternatively, user can modify the value by pressing the [REL#] button followed by using the knob or number keys to enter a specified value. Press the [REL] button again to disable null operation.

Activate Relative measurement Press the REL key. The measurement reading at the moment becomes the reference value. 1 REL#
REL

Relative measurement display appears

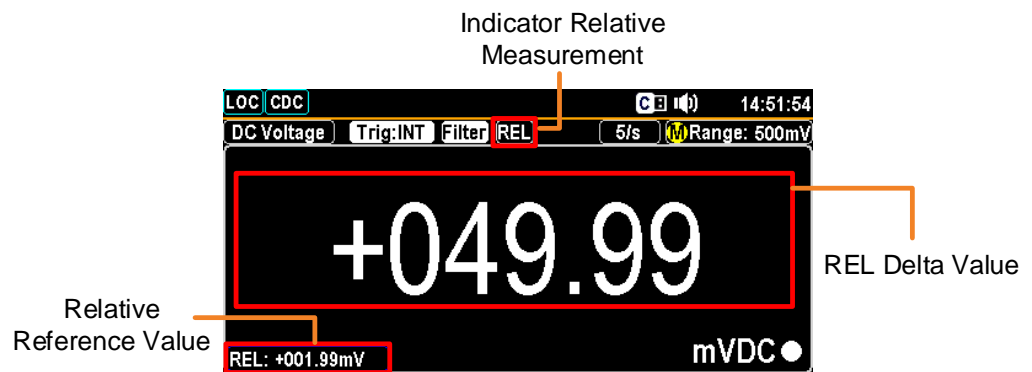

REL Indicates Relative value measurement

REL: +001.99mV Shows the stored reference value

+049.99

Shows the delta between the current measurement data and the reference value

Manually set the reference value

To set the reference (REL) value manually, press the Shift key followed by the REL key. The setting appears.

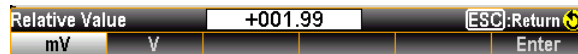
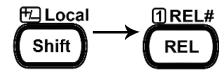

First use function keys to decide unit value. Then use the Left/Right arrow keys to move cursor and Up/Down arrow keys or press Number keys to enter the desired value.



Press the F6 (Enter) key or the physical Enter key to confirm the relative value setting.



Deactivate Relative measurement

To cancel the Relative measurement, press the REL key again, or simply activate another measurement.



Hold Measurement

Applicable to 8 ACI 7 DCI 9 4 AC 5 TEMP
ACV DCV ΩW FREQ →←

Background The Hold Measurement function retains the current measurement data and updates it only when it exceeds the set threshold (as a percentage of the retained value).

Activate Hold measurement Press the Hold key to activate Hold measurement. 2 Hold#
Hold

Hold measurement display appears

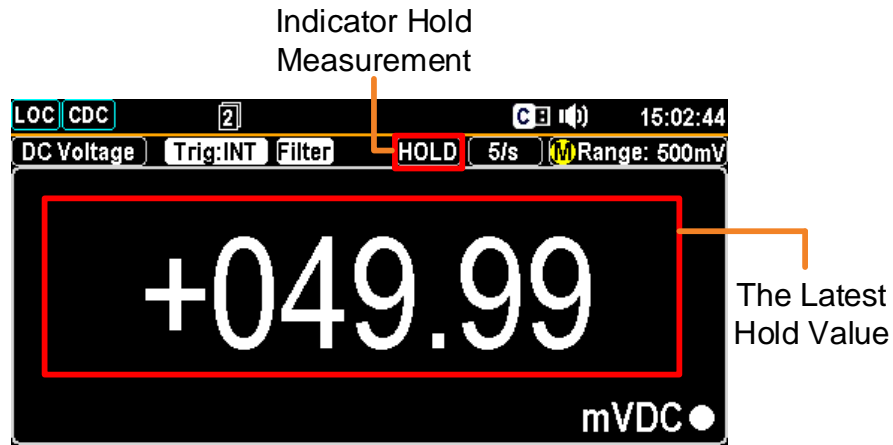

Hold Indicates Hold measurement

+049.99 mVDC Shows the latest hold value

Enter hold settings Press the Shift + Hold key to activate detailed setting menu of Hold mode as the figure below. Local 2 Hold#
Shift → Hold



F2 (BeepVol) key to define beep volume Press the F2 (BeepVol) key to show the menu of Volume level of Beep as the following. BeepVol



Press the F2 - F4 key to select volume level. Once the latest hold value is updated, the beep sounds based on the defined volume. Press the F1 key to set Beep volume off.

F3 (Percent)
key to define
threshold

Press the F3 (Percent) key to show the setting menu of Hold Percent as the figure below.

Percent

Hold Percent				ESC:Return
0.01%	0.1%	1%	10%	

Press F1 to F4 key to select desired hold percent. For example, once the measured value is beyond 10%, which corresponds to the selected 10% option here, the latest hold value will be updated on the main reading.

F6 (HoldValue)
key to restart

Press the F6 (HoldValue) key to simply Restart the hold value.

HoldValue

Function	BeepVol	Percent	HoldValue
Hold On	Small	0.1%	ReStart

Trigger Setting

Automatic/Single Triggering

Applicable to 8 ACI 7 DCI 9 6 4 +/− 5 TEMP
ACV DCV Ω2W ••• FREQ ▶

INT (Auto) triggering (default) By default, the GDM-9041/9042 triggers according to the refresh rate automatically. See the previous page for refresh rate setting details. The figure below shows the screen of INT (Auto) Trigger measurement.

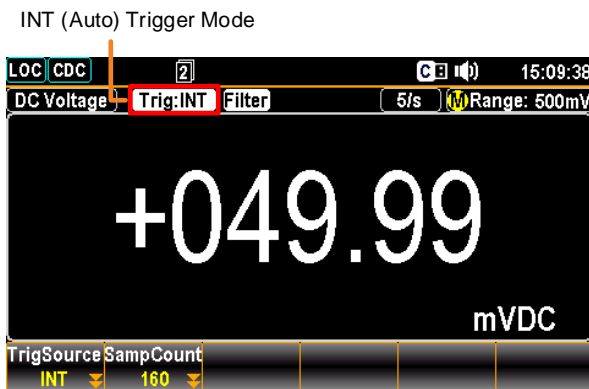

SIN (Manual) Triggering Press the TRIG key to SIN (Manual) trigger measurement. See below for details.

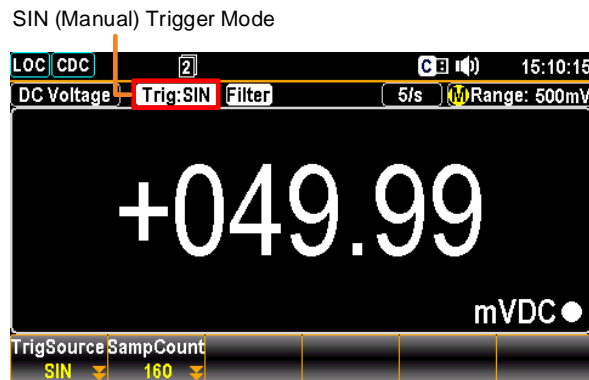

- Change mode**
- Under SIN (Manual) Trigger mode, press and hold the TRIG button for at least 2 second to return to INT (Auto) Trigger mode.
 - Under INT (Auto) Trigger mode, simply press the TRIG button to return to SIN (Manual) Trigger mode.



Filter Setting

Digital Filter Overview

Applicable to



Filter basics

The GDM-9041/9042 internal digital filter converts the analog input signal into digital format before passing it to internal circuits for processing. The filter affects the amount of noise included in the measurement result.

Filter type

The digital filter averages a specific number of input signal samples to generate one reading. The filter type defines the averaging method. The following diagrams highlight the differences between the Moving and Repeating filter using 4 samples per reading.

Moving
(default)

The Moving filter takes in one new sample and discards the oldest sample per reading. This is the default behavior when the digital filter is not specified, and is recommended for most applications.

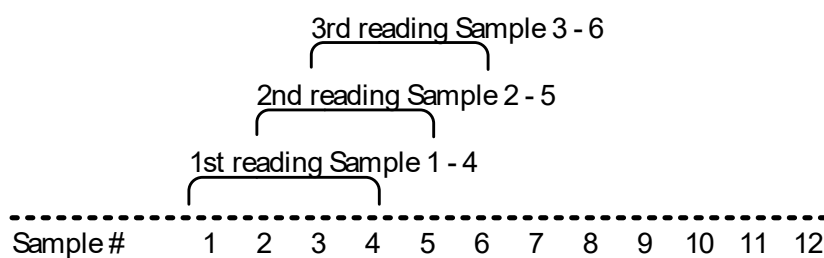

Repeating

The Repeating filter renews a whole group of samples per reading.

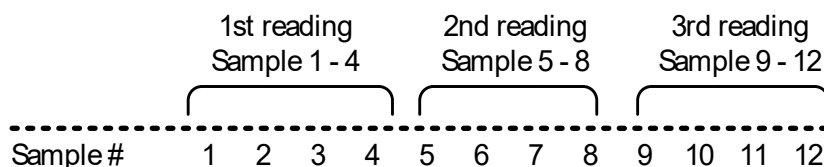

Filter count Filter count defines the number of samples to be averaged per reading. More samples offer low noise but a long delay. Less samples offer high noise but a short delay.

Range 2 to 160

Filter window Filter window defines the threshold for when the digital filter data is updated again. When the AD data falls in the range between TH and TL, the filter keeps processing. When the AD data falls out of the range between TH and TL, the filter will restart. When measuring unstable signals, appropriately setting the filter window can improve the measurement speed.

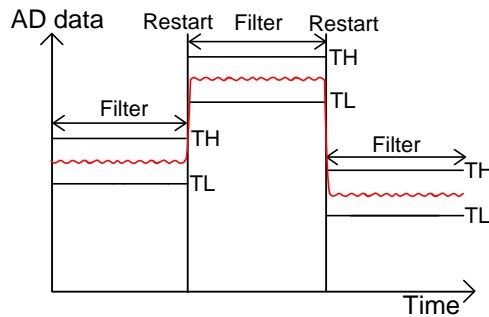

TH: Threshold High, TL: Threshold Low

Filter window Formula

Measure:

$$\text{Previous Meas} * (1 - \text{window}) < \text{threshold} < \text{Previous Meas} * (1 + \text{window}).$$

There are 5 windows range settings that can be chosen: 10%, 1%, 0.1%, 0.01% and none

Digital Filter Setting

Filter setting Press the Shift + Filter keys. The Filter setting menu will be shown as the figure below.

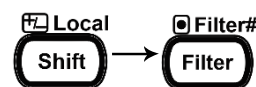

Choose Filter Type Press the F1 (FilterType) key to enter the subsequent menu. Press the F1 or F2 keys to select desired filter type.



Define Filter Count Press the F2 (FilterCount) key to enter the subsequent menu. the Left/Right arrow keys to move cursor and Up/Down arrow keys or press Number keys to enter the desired value.



Press the F6 (Enter) key or the Physical Enter key to confirm the filter count settings.



Range: 2 to 160



Define Filter Window Press the F3 (Window) key to enter the subsequent menu. Press the F1 – F5 keys to choose desired Filter Window percentage.



Range 0.01%, 0.1%, 1%, 10%, None

Turn On/Off Filter Press the Filter key to toggle between On and Off the Filter function. When it is turned On, the Filter indicator appears on the display.



Filter function indicator

Indicator Filter function

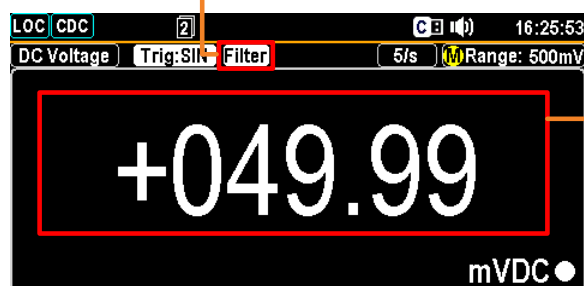

The filtered value

Math Measurement

Applicable to



Background

Math measurement runs 6 types of mathematical operations, dBm, dB, Compare, MX+B, 1/X and Percent, based on the other measurement results.

Math Equation

dBm	$10 \times \log_{10} (1000 \times V_{\text{reading}}^2 / R_{\text{ref}})$
dB	$\text{dBm} - \text{dBm}_{\text{ref}}$
Compare	Checks and updates if measurement data stays between the specified upper (high) and lower (low) limit.
MX+B	Multiplies the reading (X) by the factor (M) and adds/subtracts offset (B).
1/X	Divides 1 by the reading (X).
Percentage	Runs the following equation. $\frac{(\text{ReadingX} - \text{Reference})}{\text{Reference}} \times 100\%$

dBm/dB/Watt Measurement

Applicable to



Background

Using the ACV or DCV measurement result, the GDM-9041/9042 calculates the dBm, dB or Watt value based on a reference resistance value in the following way.

Equation

dBm	$10 \times \log_{10} (1000 \times V_{\text{reading}}^2 / R_{\text{ref}})$
dB	$\text{dBm} - \text{dBm}_{\text{ref}}$
Watt	$V_{\text{reading}}^2 / R_{\text{ref}}$

Parameters

Vreading	Input Voltage, ACV or DCV
Rref	Reference resistance simulating an output load
dBmref	Reference dBm value

Measure dBm/Watt

Applicable to	8 ACI ACV	7 DCI DCV
Equation	dBm	$10 \times \log_{10} (1000 \times V_{\text{reading}}^2 / R_{\text{ref}})$
	Watt	$V_{\text{reading}}^2 / R_{\text{ref}}$
Parameters	Vreading	Input Voltage, ACV or DCV
	Rref (REF Ω)	Reference resistance simulating an output load

Activate dBm Press the Shift key + Math key to activate Math setting menu as the following figure shown.

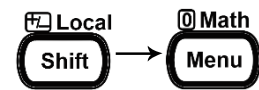

Further press the F1 (Function) key to enter the Math Function menu as the figure shown below.



Press F3 (dBm) key to enable the dBm function. The screen, after activation, will appear as figure below.



Indicator dBm On

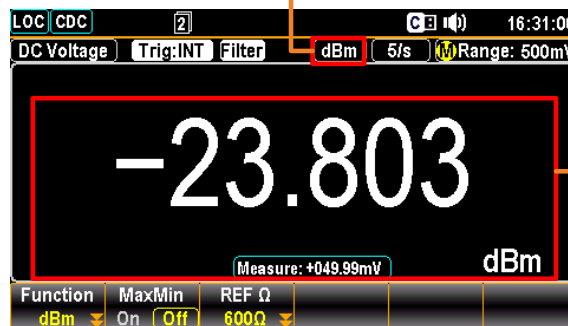

Measured dBm Value

Maximum & Minimum display Press the F2 (MaxMin) key to have the maximum and minimum measured values shown on the display.



Max. and Min measured values

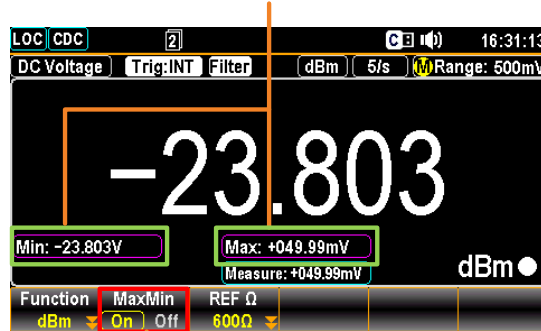

Max/Min display On

Select reference resistance (REF Ω) To change the reference resistance, press the F3 (REF Ω) key to enter the setting menu. Use the Left/Right arrow keys to move cursor and Up/Down arrow keys or press Number keys to enter the desired value of reference resistance.



Push the physical Enter key or press the F6 (Enter) key to confirm the input reference resistance.



Resistance List	2	4	8	16	50	75	93
	110	124	125	135	150	250	300
	500	600	800	900	1000	1200	8000

View result in Watt When the reference resistance is less than 50Ω, it is possible to calculate the watt value. If the reference resistance is greater than 50Ω, please ignore this step.

To calculate the Watt power, press the F1 (Function) key followed by clicking the F3 (dBm) key again.



Watt result appears

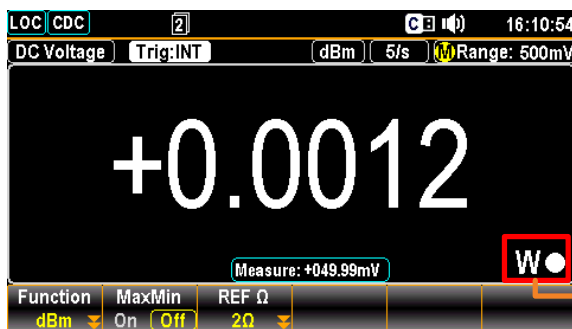

The measured B (Watt) reading

Deactivate dBm/Watt measurement

To cancel the dBm/Watt measurement, press the F1 (Function) key followed by clicking F1 (OFF) key to deactivate it or simply activate another measurement.



Measure dB

Applicable to



Equation

dB	$\text{dBm} - \text{dBmref}$
dBm	$10 \times \log_{10} (1000 \times V_{\text{reading}}^2 / R_{\text{ref}})$

Parameters

dBmref	Reference dBm value
--------	---------------------

Background

dB is, specifically, defined as [dBm-dBmref]. When the dB measurement is activated, the GDM-9041/9042 calculates the dBm using the reading at the first moment and stores it as dBmref.

Activate dB

Press the Shift + Math key to activate Math setting menu as the following figure shown.

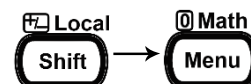

Further press the F1 (Function) key to enter the Math Function menu as the figure shown below.



Press F2 (dB) key to enable the dB function. The screen, after activation, will appear as figure below.



dB result appears

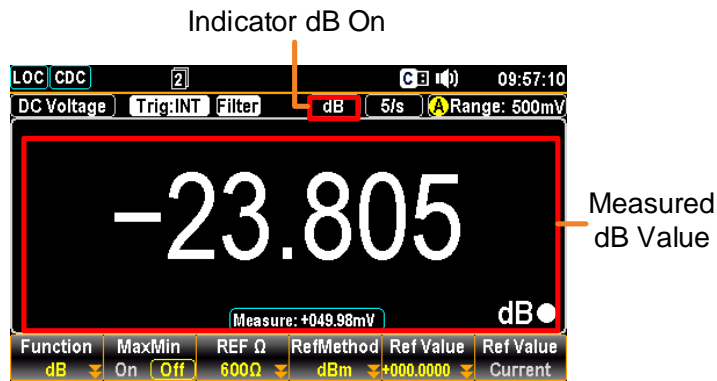

Max & Min display

Press the F2 (MaxMin) key to have the maximum and minimum measured values shown on the display.



Max. and Min measured values

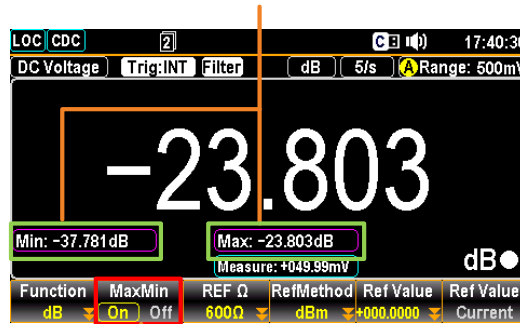

Max/Min display On

Select reference resistance (REF Ω)

To change the reference resistance, press the F3 (REF Ω) key to enter the setting menu. Use the Left/Right arrow keys to move cursor and Up/Down arrow keys or press Number keys to enter the desired value of reference resistance.



Push the physical Enter key or press the F6 (Enter) key to confirm the input reference resistance.

Enter or



Resistance List	2	4	8	16	50	75	93
	110	124	125	135	150	250	300
	500	600	800	900	1000	1200	8000

F4 (Ref Method) to select dB reference method Reference method involves the ways to calculate dB value. When dBm option is selected, user can specify a definite dBm value for dB calculation. If selecting Voltage option, system regards the defined voltage value as the Vreading parameter for dBm calculation, thus resulting in different dB value than the previous option.

Press the F4 (RefMethod) key to enter the dB Ref Method menu followed by clicking the F1 (dBm) or F2 (Voltage) key to determine which method of calculation to proceed to.

RefMethod

dBm

Voltage



F5 (Ref Value) to define reference value (voltage or dBm)

In order to define either voltage or dBm reference value, both of which are corresponding to the previous F4 (Ref Method) option, press the F5 (Ref Value) to enter the dB Ref Value menu, and use the Left/Right arrow keys to move cursor and Up/Down arrow keys or press Number keys to enter the desired Ref value. Press the F6 (Enter) key or Physical Enter key to confirm the input value.



Ref Value

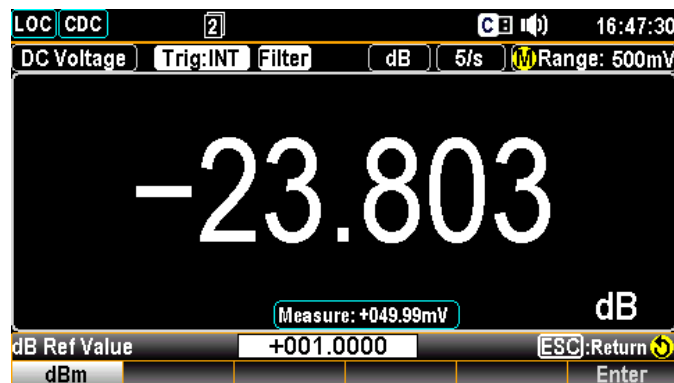

Enter

Note: when setting voltage Ref value, press the function keys to promptly define the unit.



F6 (Ref Value) key to set the dBm reference	Press the F6 (Ref Value_Current) key to instantly make the current dBm value, which is calculated by the current input voltage with the equation, as the Ref dBm (dBm reference).	
Deactivate dB measurement	To cancel the dB measurement, press the F1 (Function) key followed by clicking F1 (OFF) to deactivate it or simply activate another measurement.	

Compare Mode

Applicable to **8 ACI** **7 DCI** **9** **4 +f** **5 TEMP**
ACV **DCV** **Ω2W** **FREQ** **→**

Background The Compare mode checks and updates if measurement data stays between the specified upper (high) and lower (low) limit.

Activate Compare mode Press the Shift + Math key to activate Math setting menu as the following figure shown.



Further press the F1 (Function) key to enter the Math Function menu as the figure shown below.



Press F4 (COMP) key to enable the Compare function. The screen, after activation, will appear as figure below.

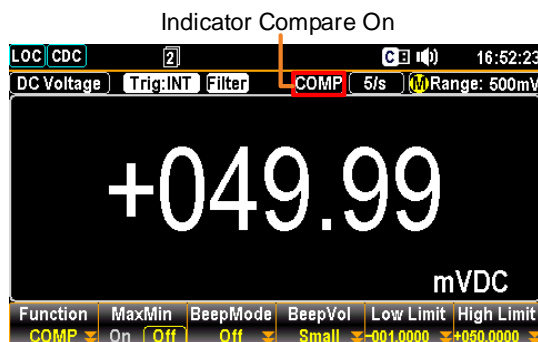

Max & Min display

Press the F2 (MaxMin) key to have the maximum and minimum measured values shown on the display.



Max. and Min measured values

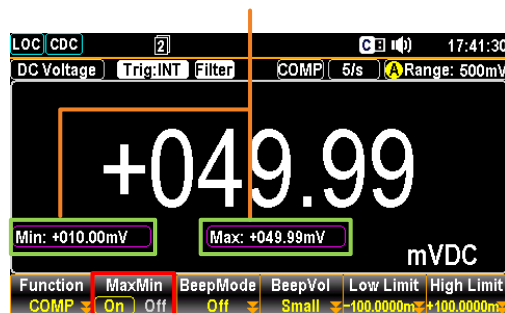

F6 (High Limit) to set high limit

Press the F6 (High Limit) key to enter the setting menu.

High Limit



First use the functions keys to determine the unit, which varies by different measure modes. Then use function keys to decide unit value. Then use the Left/Right arrow keys to move cursor and Up/Down arrow keys or press Number keys to enter the desired value of high limit.



Push the F6 (Enter) key or the physical Enter key to make the setting into effect.

Enter or



F5 (Low Limit) to set low limit

Press the F5 (Low Limit) key to enter the setting menu.

Low Limit



First use the functions keys to determine the unit, which varies by different measure modes. Then use function keys to decide unit value. Then use the Left/Right arrow keys to move cursor and Up/Down arrow keys or press Number keys to enter the desired value of low limit.



Push the F6 (Enter) key or the physical Enter key to make the setting into effect.

Enter or



F3 (BeepMode) to define beep mode

Press the F3 (BeepMode) key to enter the beep mode setting. By enabling beep mode, user can be aware of the latest state promptly by beep voice.

BeepMode

The display shows as the figure below. Press the F2 (Pass) or F3 (Fail) key to determine the condition of beep alarm.

Press the F1 (Off) key to disable beep mode.

Pass

or

Fail

Off



F4 (BeepVol) Press the F4 (BeepVol) key to enter the beep
to select volume setting. **BeepVol**
beep volume Select the intensity of beep volume via pressing **Small** or
F1 – F3 key for desired level as the figure shown **Medium** or
below. **Large**



Compare mode result When the measured result is within the range of high and low
limit, the display shows as the figure below with purely black
background indicating the state of “Pass”.



However, when measured result is either above or less than
the limit range, the display appears as the figure below with
boldly red background indicating the state of “Fail”.



See the contents below for more details of each state in
compare mode

Deactivate Compare measurement To cancel the Compare measurement, press the **Function**
F1 (Function) key followed by clicking F1 (OFF) **OFF**
to deactivate it or simply activate another measurement.

MX+B Measurement

Applicable to **8 ACV** **7 DCV** **9 Ω2W** **4 ±f** **5 TEMP**

Activate MX+B Press the Shift + Math key to activate Math setting menu as the following figure shown.

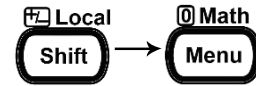

Further press the F1 (Function) key to enter the Math Function menu as the figure shown below.

Function



Press F5 (MX+B) key to enable the MX+B function. The screen, after activation, will appear as figure below.

MX+B

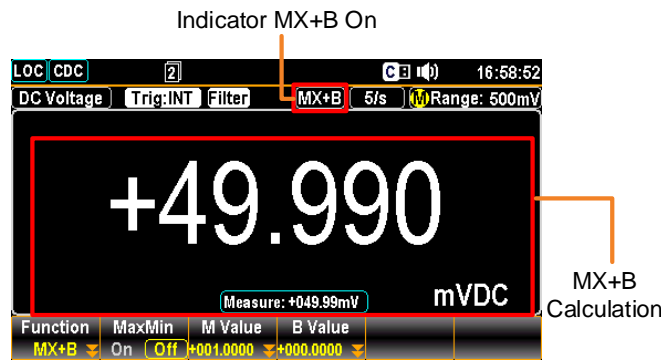

Max & Min display Press the F2 (MaxMin) key to have the maximum and minimum measured values shown on the display.

MaxMin

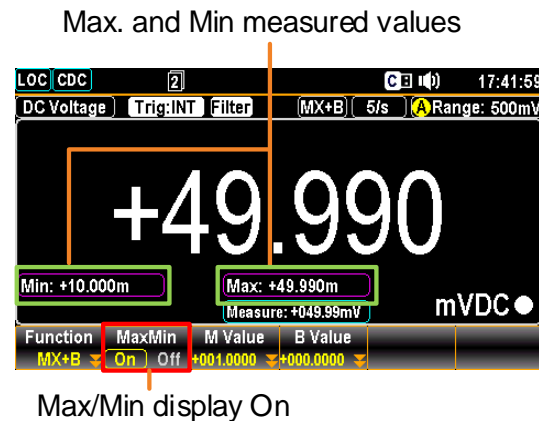

F3 (M Value) key Press the F3 (M Value) key to enter the MX+B M Value menu. First use function keys to decide unit value, which may vary by different measurements. Then use the Left/Right arrow keys to move cursor and Up/Down arrow keys or press Number keys to enter the desired value. See the figure below.

M Value



Press the F6 (Enter) key or the physical Enter key to confirm the input M value.

Enter or



F4 (B Value) key Press the F4 (B Value) key to enter the setting menu. First use function keys to decide unit value, which may vary by different measurements. Then use the Left/Right arrow keys to move cursor and Up/Down arrow keys or press Number keys to enter the desired value. See the figure below.

B Value

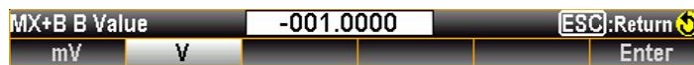

Press the F6 (Enter) key or the physical Enter key to confirm the input B value.

Enter or



Deactivate MX+B measure To cancel the MX+B measurement, press the F1 (Function) key followed by clicking F1 (OFF) key to deactivate it or simply activate another measurement.

Function

OFF

1/X Measurement

Applicable to **8 ACI** **7 DCI** **9** **4 1X** **5 TEMP**
ACV **DCV** **Ω2W** **FREQ** **→**

Activate 1/X Press the Shift + Math key to activate Math setting menu as the following figure shown.

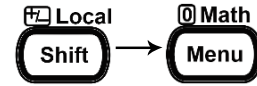

Further press the F1 (Function) key to enter the Math Function menu as the figure shown below.

Function



Press F6 (More 1/2) key to enter the next page followed by pressing the F1 (1/X) key.

More 1/2



1/X

The 1/X function will be activated as the figure below.

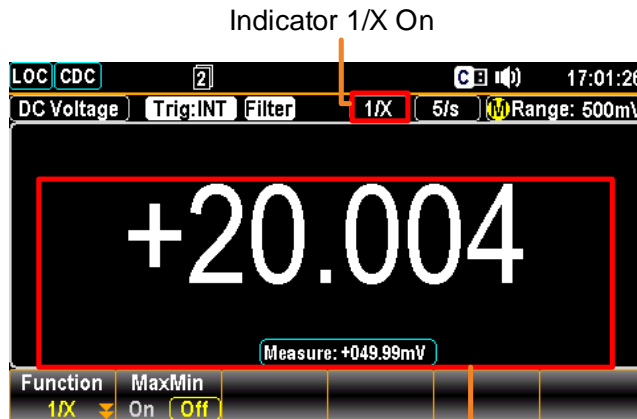

Max & Min display

Press the F2 (MaxMin) key to have the maximum and minimum measured values shown on the display.

MaxMin

Max. and Min measured values

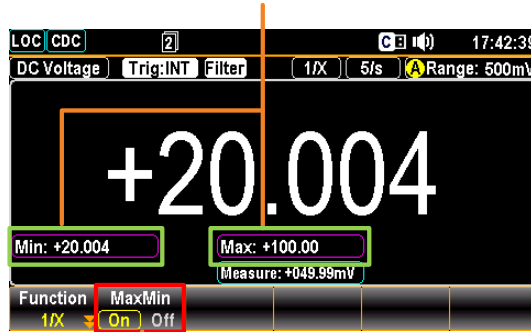

Max/Min display On

Deactivate 1/X measurement

To cancel the 1/X measurement, press the F1 (Function) key followed by clicking the F1 (OFF) key to deactivate it or simply activate another measurement.

Function
OFF

Measure Percent

Applicable to **8 ACI** **7 DCI** **9 Ω2W** **4 ±f** **5 TEMP**
ACV **DCV** **Ω2W** **FREQ** **→**

Activate percent Press the Shift + Math key to activate Math setting menu as the following figure shown.



Further press the F1 (Function) key to enter the Math Function menu as the figure shown below.



Press F6 (More 1/2) key to enter the next page followed by pressing the F2 (PERC) key.



The Percent function will be activated as the figure below.

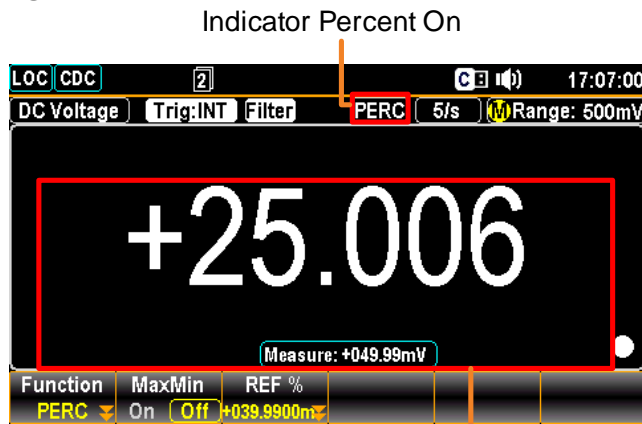

The Measured Percent Value

Max & Min display Press the F2 (MaxMin) key to have the maximum and minimum measured values shown on the display.

MaxMin

Max. and Min measured values

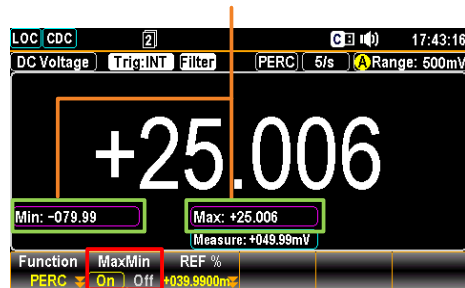

Max/Min display On

F3 (REF %) Press the F3 (REF %) key to enter the Percent REF % menu. First use the functions keys to determine the unit, which may vary by different measure modes. Then use the Left/Right arrow keys to move cursor and Up/Down arrow keys or press Number keys to enter the desired value. See the figure below.

REF %

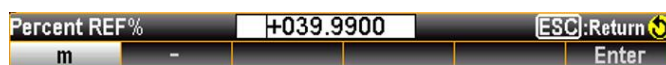

Push the physical Enter key or press the F6 (Enter) key to confirm the input value.

Enter or



Deactivate percent measurement To cancel the percent measurement, press the F1 (Function) key followed by clicking F1 (OFF) to deactivate it or simply activate another measurement.

Function OFF

SYSTEM & FIRMWARE

View System Info 89

View System Info

Background View system information including Vendor, Model Name, Serial Number, Master Firmware and Slave Firmware.

- Step**
1. Press the Menu key, the System configuration menu appears. And press the NEXT key repeatedly to move to the Cali&Info – SystemInfo field.

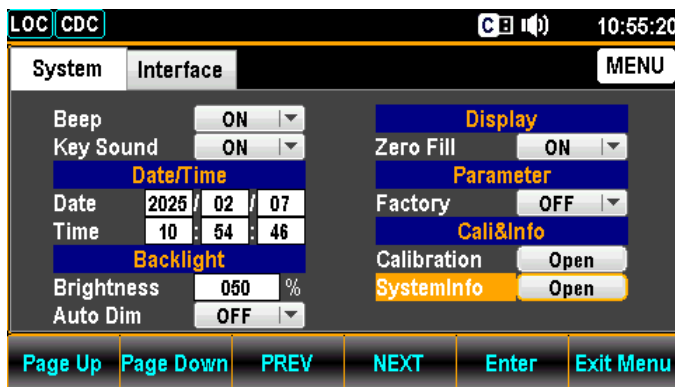

2. Press the F5 (Enter) key or physical Enter key to enter the System Information where all the contents are clearly exposed.

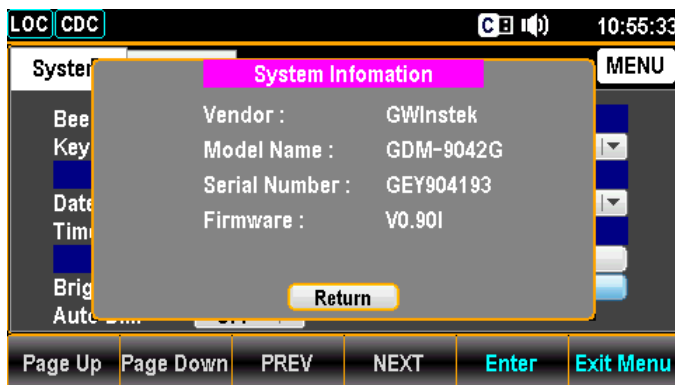

MENU SETTING

Configure System	91
Beep Setting	91
Key Sound Setting	92
Date Setting	93
Time Setting	94
Brightness Setting	95
Auto Dim Setting.....	96
Zero Fill Setting.....	97
Factory Setting.....	98
Calibration Setting	99
View System Info	99

Configure System

Beep Setting

Background Enable or Disable Beep Sound.

- Step 1. Press the Menu key, the System configuration menu appears.

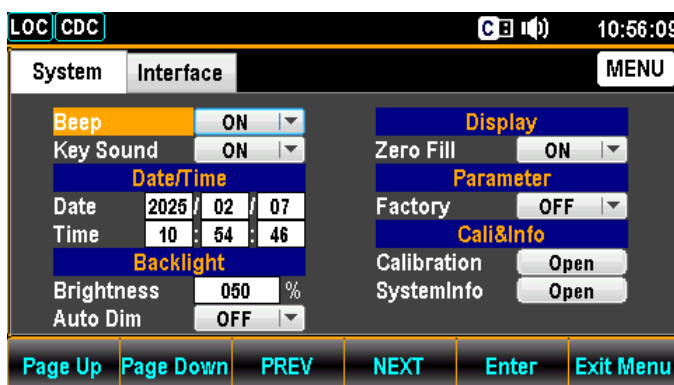

2. Press the F5 (Enter) key or physical Enter key followed by pressing up and down arrow keys to land on the ON option.

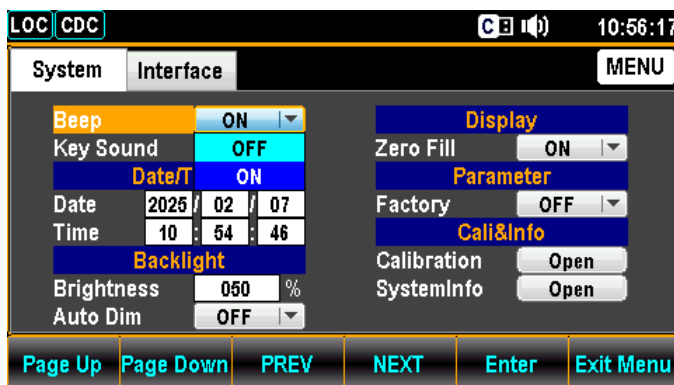

3. Press the F5 (Enter) key or physical Enter key to select the ON option for beep setting.



Key Sound Setting

Background Enable or Disable Key Sound.

- Step 1. Press the Menu key, the System configuration menu appears. And press the NEXT key repeatedly to move to the Key Sound field.

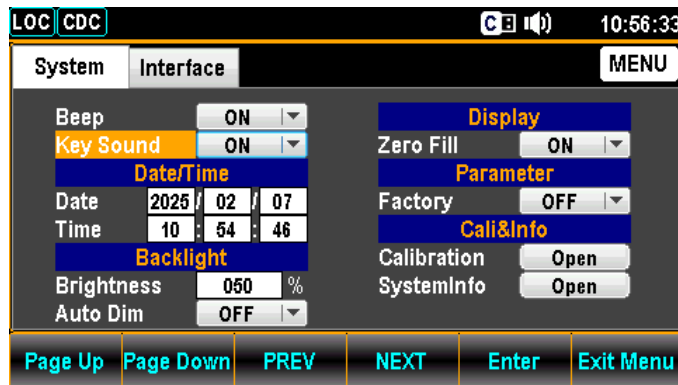
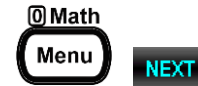

2. Press the F5 (Enter) key or physical Enter key followed by pressing up and down arrow keys to land on the ON option.

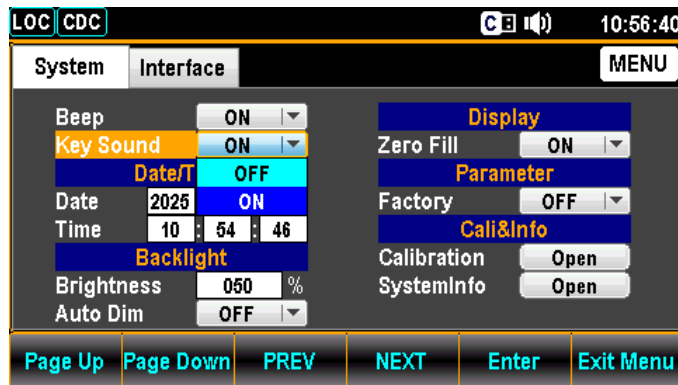

3. Press the F5 (Enter) key or physical Enter key to select the ON option for key sound.



Date Setting

Background Manually adjust date for system.

- Step
1. Press the Menu key, the System configuration menu appears. And press the NEXT key repeatedly to move to the Date/Time – Date field.

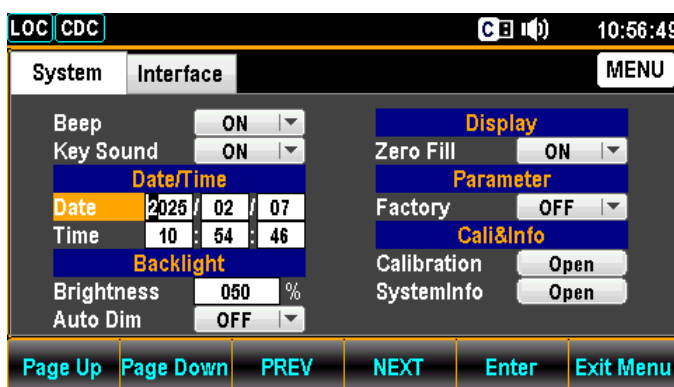
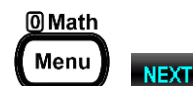

2. Use the Left/Right arrow keys to move the cursor followed by pressing Up/Down arrow keys or press Number keys to define year of Date.

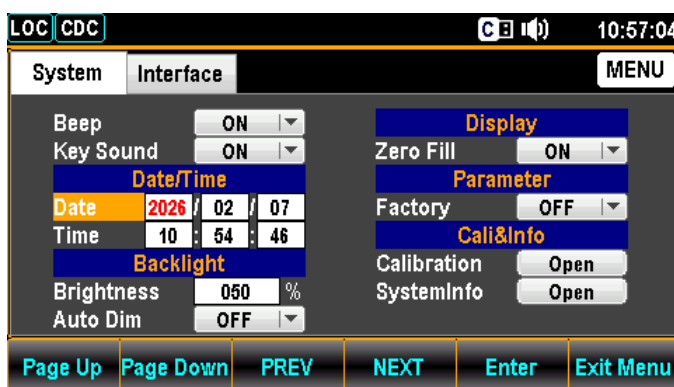

3. Press the F5 (Enter) key or physical Enter key to confirm the input digit for year of Date.

Enter



4. Repeat steps 2 to 3 for month and day.

Time Setting

Background Manually adjust time for system.

- Step
1. Press the Menu key, the System configuration menu appears. And press the NEXT key repeatedly to move to the Date/Time – Time field.

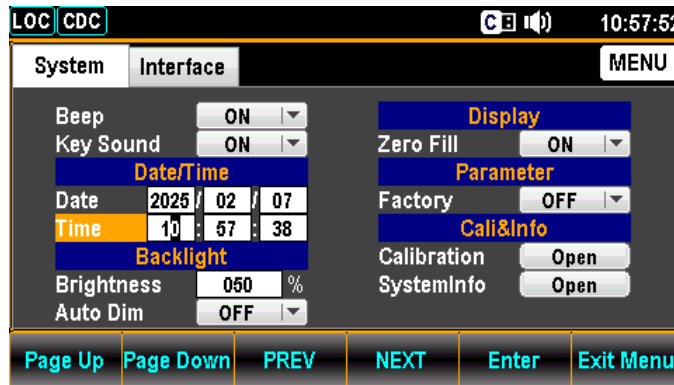
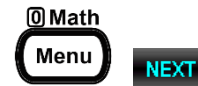

2. Use the Left/Right arrow keys to move the cursor followed by pressing Up/Down arrow keys or press Number keys to define hour of Time.

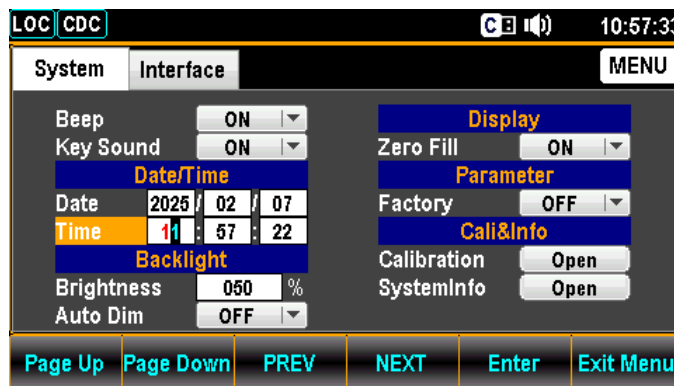

3. Press the F5 (Enter) key or physical Enter key to confirm the input digit for hour of Time.



4. Repeat steps 2 to 3 for minute and second.

Brightness Setting

Background Backlight brightness adjustment

Step

1. Press the Menu key, the System configuration menu appears. And press the NEXT key repeatedly to move to the Backlight – Brightness field.

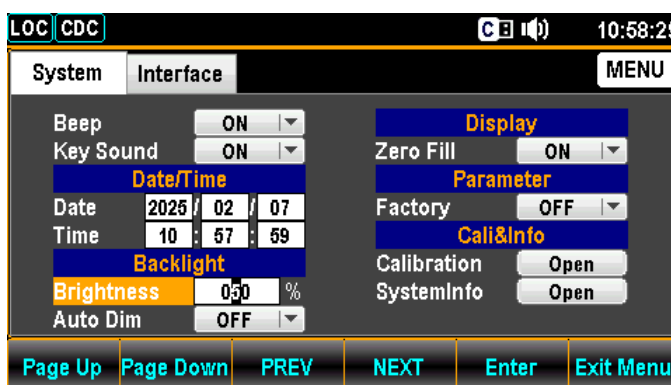
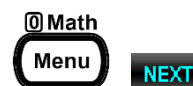

2. Use the Left/Right arrow keys to move the cursor followed by pressing Up/Down arrow keys or press Number keys to define digit.

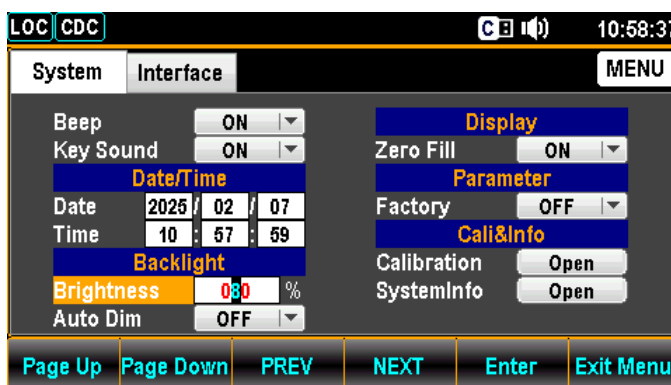

3. Press the F5 (Enter) key or physical Enter key to confirm the input digit for backlight brightness.

Enter



Auto Dim Setting

Background Set a duration before activation of automatic dim out for screen display.

- Step**
1. Press the Menu key, the System configuration menu appears. And press the NEXT key repeatedly to move to the Backlight – Auto Dim field.

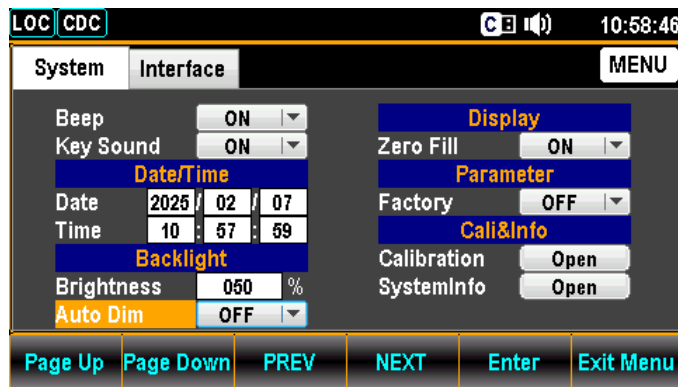
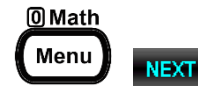

2. Press the F5 (Enter) key or physical Enter key followed by pressing up and down arrow keys to land on a desired option.

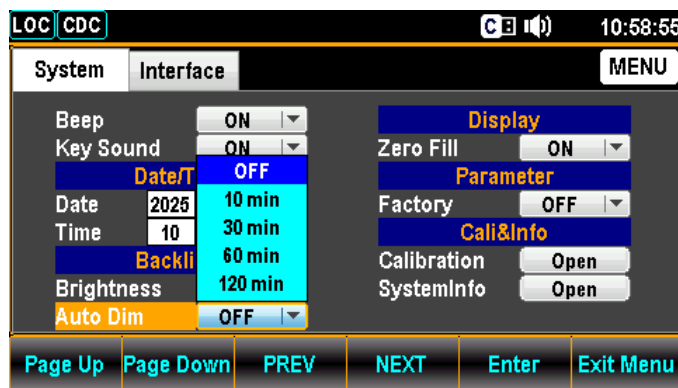

3. Press the F5 (Enter) key or physical Enter key to confirm the setting for backlight auto dim.



Zero Fill Setting

Background Automatically omit the redundant zero “0” values displayed, which makes measured reading more concise.

- Step**
1. Press the Menu key, the System configuration menu appears. And press the NEXT key repeatedly to move to the Display – Zero Fill field.

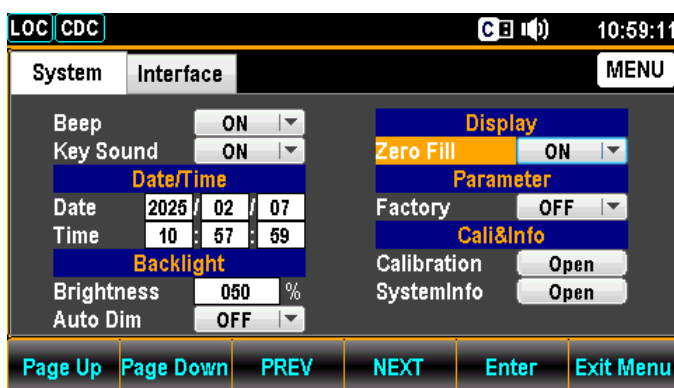
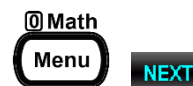

2. Press the F5 (Enter) key or physical Enter key followed by pressing up and down arrow keys to land on the ON option.

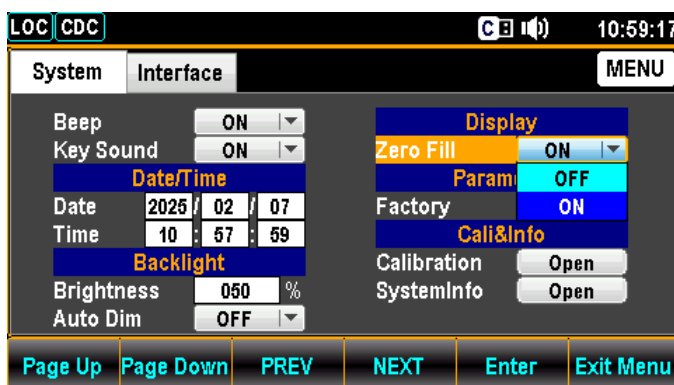

3. Press the F5 (Enter) key or physical Enter key to select the ON option for zero fill.



Factory Setting

Background The Factory function restores the unit back to the factory default settings.

- Step**
1. Press the Menu key, the System configuration menu appears. And press the NEXT key repeatedly to move to the Parameter - Factory field.

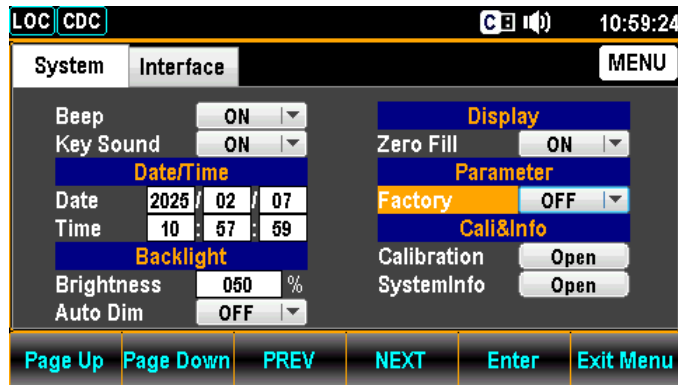
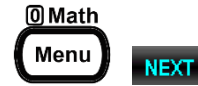

2. Press the F5 (Enter) key or physical Enter key followed by pressing up and down arrow keys to land on the ON option.

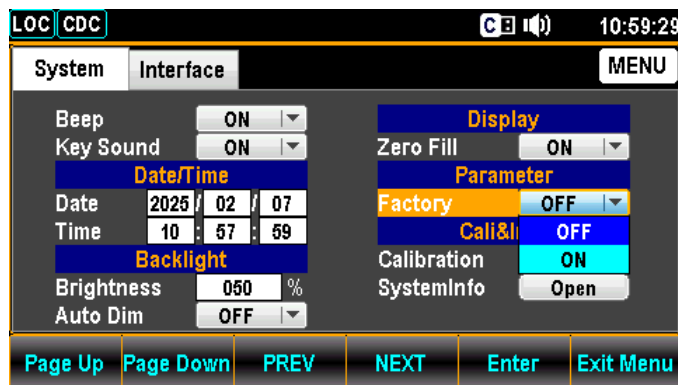

3. Press the F5 (Enter) key or physical Enter key to restore back to the default settings.



Calibration Setting

Background With granted password, the calibration procedure can be only executed by the certified technician in accordance with the standard instruments. Refer to the manufacturer or qualified personnel of authorized dealer for details.

View System Info

Background View system information including Vendor, Model Name, Serial Number, Master Firmware and Slave Firmware.

- Step**
1. Press the Menu key, the System configuration menu appears. And press the NEXT key repeatedly to move to the Security&Info – SystemInfo field.

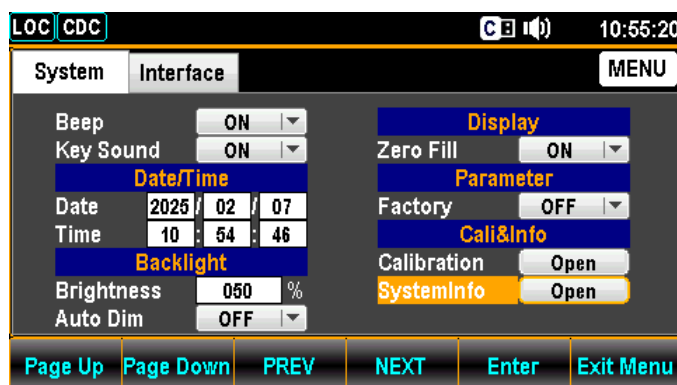
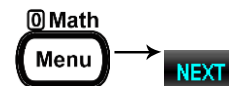

2. Press the F5 (Enter) key or physical Enter key to enter the System Information where all the critical contents are exposed for check.



SCREENSHOT & LOG

Capture	101
Save Data Log	102

Capture

Background Configure the mode of screenshot capturing.

Supported USB Sticks:

USB Disk Type: Flash Disk Only

FAT Format: Fat16 or Fat32(Recommended)

Max memory size: 128 GB



Note Flash disks which need to use card adaptors are not recommended to be used in this application.

Step

1. Press the Shift key followed by the LOG/LOG# key and the following menu appears.



2. Press the F1 (Log Mode) key followed by clicking the F1 (Capture) key to enable the Capture mode for screenshot.



Number Range The auto name in serial number ranges from SCREEN00 to SCREEN99.



Note When the serial number reaches the maximum, e.g., SCREEN99, the save action will be Not available.

Save Data Log

Background Configure the modes of data log saving.

Step of Simple Mode

1. Press the Shift key followed by the LOG/LOG# key and the following menu appears.

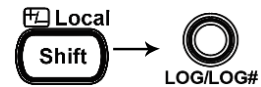

2. Press the F1 (Log Mode) key followed by clicking the F2 (Simple) key to enable the Simple mode for data log saving.



Simple Mode This mode is quite simple and hassle-free for user. It is the default operating mode for data log saving. After entering this mode, the system will set the “ExistFile“ setting to “Newfile“, “Record” setting to “Normal” and “LogCount“ setting to “Continue“ by default.

In terms of “FileName”, the system will start to seek for the first available value of file name (e.g., the first file name will basically start from GW000, if GW000 doesn’t already exist). If GW000, GW001 and GW002, for example, exist already, then GW003 would be the next available filename.

FileName in GW000

LogMode	FileName	ExistFile	Record	LogCount
Simple	GW000_XX	Newfile	Normal	Continue

FileName in GW003

LogMode	FileName	ExistFile	Record	LogCount
Simple	GW003_XX	Newfile	Normal	Continue

Step of
Advance Mode

1. Press the Shift key followed by the LOG/LOG# key and the following menu appears.

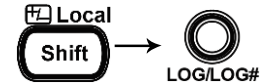

2. Press the F1 (Log Mode) key followed by clicking the F3 (Advance) key to enable the Advance mode for data log saving.



Advance Mode Users can make detailed settings in this mode. The Advance mode is more flexible, so it is comparatively more complex and only recommended for advanced users when necessary. The following settings are configurable in this mode: “FileName”, “ExistFile”, “Record”, and “LogCount”.

There are several configurations of Advance mode for user to manually set up as follows:



3. Press the F2 (FileName) key followed by manually input defined value in the field of Log File Name for data log saving.

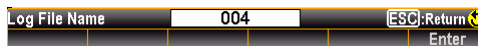

File Name The function allows user to define the value of the starting filename in red highlight below:
GW000-XX.CSV.

- The suffix, XX, is a serial number and therefore cannot be edited by user.
- If, for example, a filename with “GW000” exists in the connected USB disk, the system will define value of log file to “GW001” instead, regardless of the setting of FileName in “GW000”.

4. Press the F3 (ExistFile) key followed by selecting either Newfile or Continue option for the existed log file in USB disk.

ExistFile



Exist **Newfile**

- File**
- By default, a new file is created each time the log saving function is applied.

Continue

- The “Continue” allows user to continue saving to the previous file rather than creating a new file each time the log saving function is applied.

5. Press the F4 (Record) key followed by selecting either Normal or Long option in the field of Log Record Type for data log saving.

Record



Record **Normal**

- The Normal record mode is the regular mode. The longest recordable time depends on the refresh rate that is chosen; the longest recordable time (in seconds) equals 5,000,000/refresh rate.

Long

- In the Long record mode, a fixed record speed of one record per second will be logged into the log file; the longest recordable time is 5,000,000 seconds. It is suggested for user who needs long-term data records since, in this mode, the Rate is set by the system to the slow rate and the refresh rate is set to 1 data refresh per second.

-
6. Press the F5 (LogCount) key followed by manually input defined value in the field of Log Save Count for data log saving.



Log Count The Count function sets how many readings to perform each time the log saving function is applied. The setting is 10 by default. When this function is used, the DMM will automatically return to the ready status when the specified number of readings have been logged.

In addition, the “Continu” setting, which indicates that Log Count is set “00000”, will continuously log data until the USB log saving function is turned off. Besides, when it is under Continu setting, the actual number of reading counts is at the maximum of 5,000,000 (50,000 readings * 100).

REMOTE CONTROL

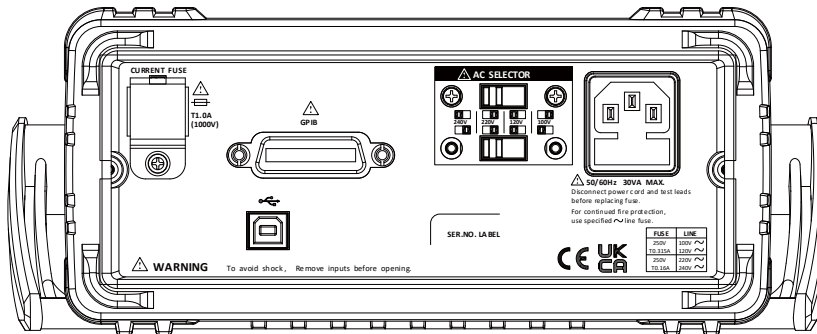

Configure Interface	107
Return to Local Control Mode	107
Configure SCPI ID Setting.....	107
Configure USB Interface	108
Set the USB Protocol	111
Configure GPIB Interface	112
Command Syntax	114
Command Set	118
Configure Commands (1 st)	118
Configure Commands (2 nd)	118
Measure Commands	119
Sense Commands.....	119
Calculate Commands.....	120
Trigger Commands	121
Display Commands.....	121
System Commands	121
Status Commands	122
Interface Commands	122
Common Command.....	123
Status system	147

Configure Interface

Return to Local Control Mode

Background When the unit is in remote control mode, the RMT icon  above the main display can be seen. When this icon is not displayed, it indicates that the unit is in local control mode.

In order to switch back to the Local control mode (front panel operation), press the Shift key.



Configure SCPI ID Setting

Background The SCPI ID can be manually configured by user. When Identity of SCPI ID is set to 834X, it indicates the pattern of commands is compatible with the previous GDM-834X models also manufactured by GW INSTEK.

Step 1. Press the Menu key, and then the Page Down key repeatedly until the Interface configuration menu appears.

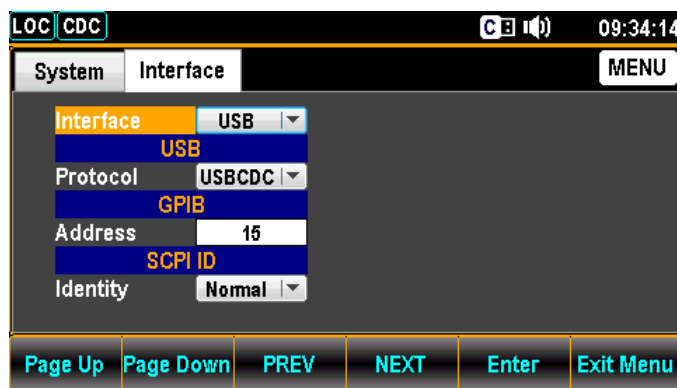
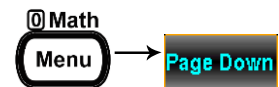

2. Press the F4 (NEXT) key repeatedly to move to the SCPI ID field.



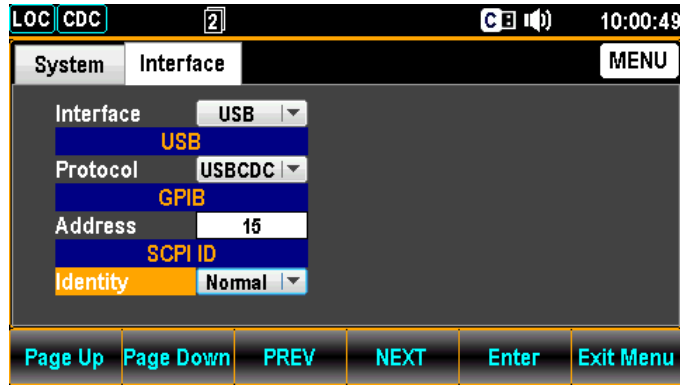

3. Press the F5 (Enter) key or physical Enter key followed by pressing up and down arrow keys to land on the desired SCPI ID Identity option.

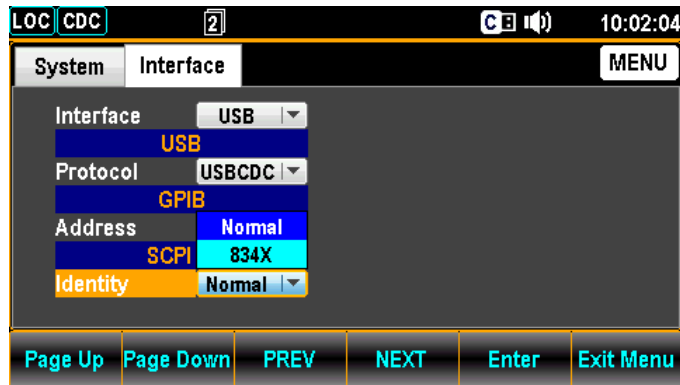

4. Press the F5 (Enter) key or physical Enter key to confirm the desired SCPI ID Identity option



Configure USB Interface

USB Configuration PC side connector Front panel, Type A, host

Unit side connector Real panel, Type B, device

USB Speed 2.0 (Full speed)

- Step
1. Press the Menu key, and then the Page Down key repeatedly until the Interface configuration menu appears.

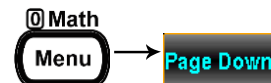

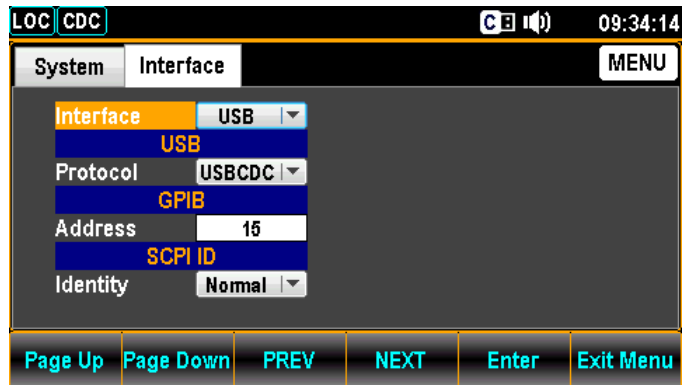

2. Press the F5 (Enter) key or physical Enter key followed by pressing up and down arrow keys to land on the USB option.

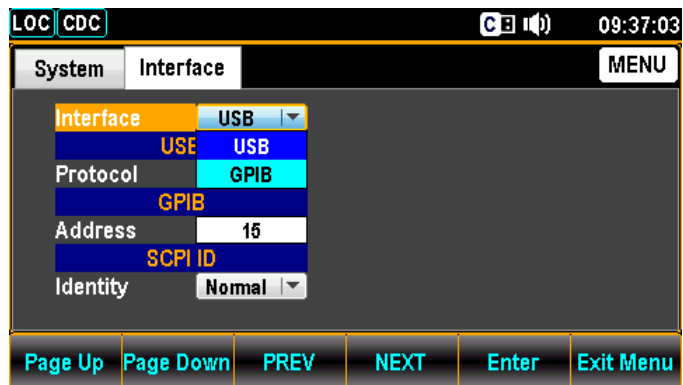

3. Press the F5 (Enter) key or physical Enter key to select the USB option.



4. Press the F4 (NEXT) key repeatedly to move to the USB - Protocol field.

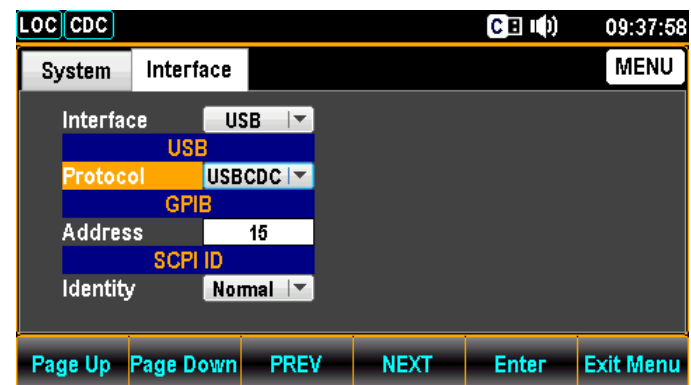

5. Press the F5 (Enter) key or physical Enter key followed by pressing up and down arrow keys to land on the desired USB Protocol option.

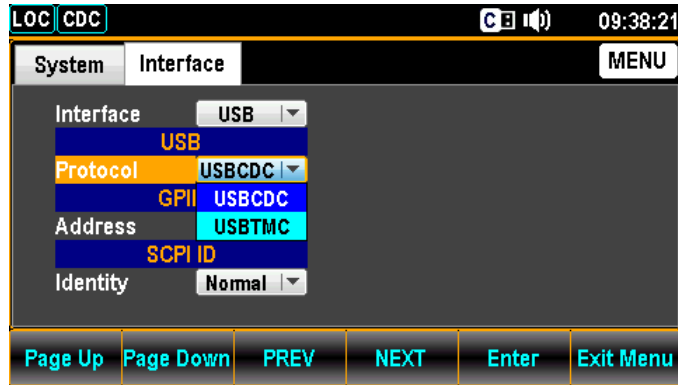

6. Press the F5 (Enter) key or physical Enter key to confirm the USB Protocol option.



7. Connect the USB cable to the rear panel terminal (upper port).

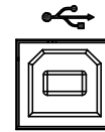

Set the USB Protocol

Description The USB device port on the rear panel is used for remote control. The USB port can be configured as either a TMC or CDC interface.

Before the GDM-9041/9042 can be used for remote control utilizing the CDC or TMC USB class, install the appropriate CDC or TMC USB driver included on the User Manual CD.

USBCDC:

The USB port on the GDM-9041/9042 will appear as a virtual COM port to a connected PC.

USBTMC:

The GDM-9041/9042 can be controlled using National Instruments NI-Visa software*. NI-Visa supports USB TMC.



*To use the TMC interface National Instruments Measurement and Automation Explorer can be used. This program is available on the NI website, www.ni.com, via a search for the VISA Run-time Engine page, or “downloads” at the following URL, <http://www.ni.com/visa/>

Configure GPIB Interface

GPIB Configuration	Connector	24 Pin female GPIB port
	Address	0-30(default 15)

- Step 1. Press the Menu key, and then the Page Down key repeatedly until the Interface configuration menu appears.

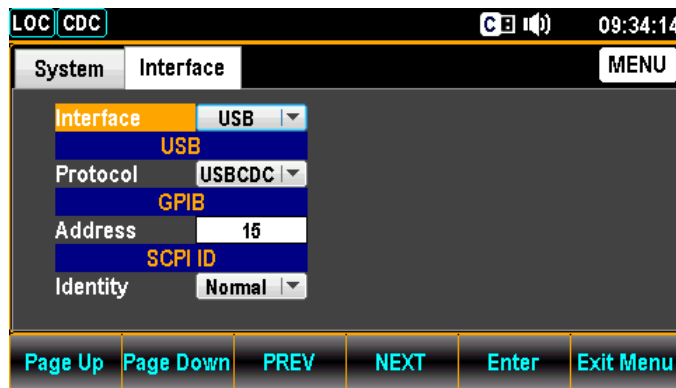
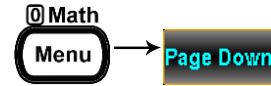

2. Press the F5 (Enter) key or physical Enter key followed by pressing up and down arrow keys to land on the GPIB option.

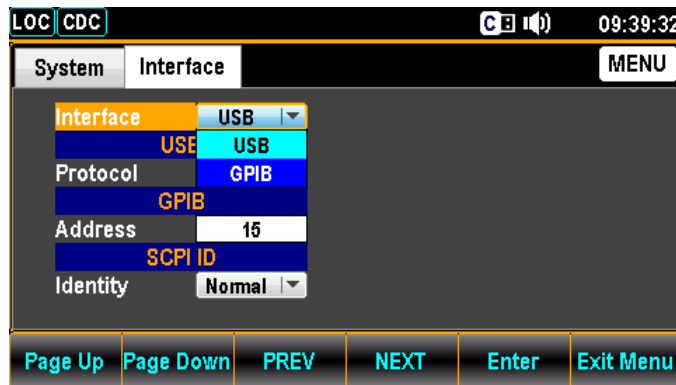

3. Press the F5 (Enter) key or physical Enter key to select the GPIB option.



4. Press the F4 (NEXT) key repeatedly to move to the GPIB - Address field.



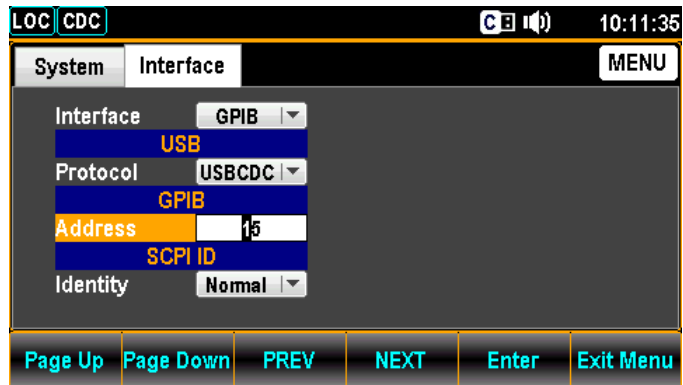

5. Use the Left/Right arrow keys to move the cursor followed by pressing Up/Down arrow keys or press Number keys to define GPIB Address.

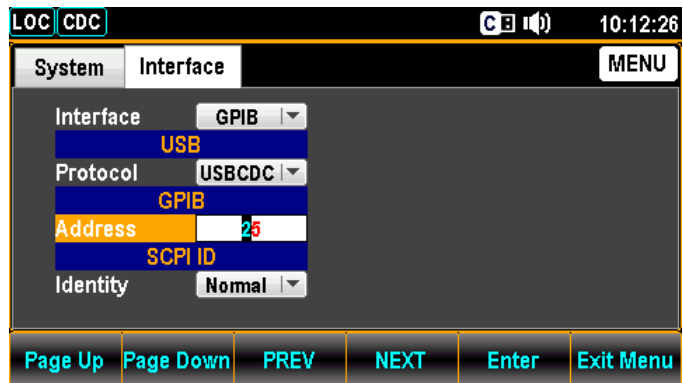

6. Press the F5 (Enter) key or physical Enter key to confirm the input GPIB Address.



7. Connect the GPIB cable to the rear panel optional communication port after the GPIB card has been installed.

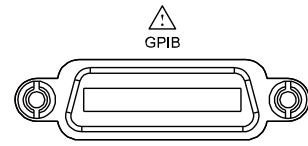

GPIB Pin Assignment

Pin	Signal	Pin	Signal
1	Data I/O 1	13	Data I/O 5
2	Data I/O 2	14	Data I/O 6
3	Data I/O 3	15	Data I/O 7
4	Data I/O 4	16	Data I/O 8
5	EOI	17	REN
6	DAV	18	Ground (DAV)
7	NRFD	19	Ground (NRFD)
8	NDAC	20	Ground (NDAC)
9	IFC	21	Ground (IFC)
10	SRQ	22	Ground (SRQ)
11	ATN	23	Ground (ATN)
12	SHIELD Ground	24	Single GND

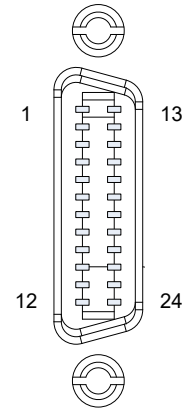

Command Syntax

Compatible Standard	IEEE488.2	Partial compatibility
	SCPI, 1994	Partial compatibility

Command Structure SCPI (Standard Commands for Programmable Instruments) commands follow a tree-like structure, organized into nodes. Each level of the command tree is a node. Each keyword in a SCPI command represents each node in the command tree. Each keyword (node) of a SCPI command is separated by a colon (:).

For example, the diagram below shows an SCPI sub-structure and a command example.

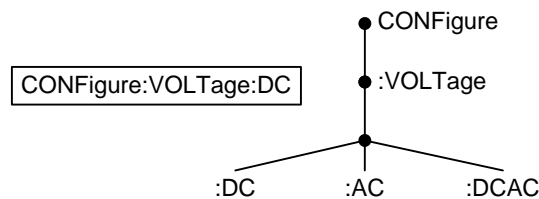

Command Types There are a number of different instrument commands and queries. A command sends instructions or data to the unit and a query receives data or status information from the unit.

Command types

Simple A single command with/without a parameter

Example CONFigure:VOLTage:DC

Query A query is a simple or compound command followed by a question mark (?). A parameter (data) is returned.

Example CONFigure:RANGe?

Command Forms Commands and queries have two different forms, long and short. The command syntax is written with the short form of the command in capitals and the remainder (long form) in lower case.

The commands can be written either in capitals or lower-case, just so long as the short or long forms are complete. An incomplete command will not be recognized.

Below are examples of correctly written commands.

Long form CONFigure:DIODe
 CONFIGURE:DIODE
 Configure:diode

Short form CONF:DIOD
 conf:diod

Square Brackets Commands that contain square brackets indicate that the contents are optional. The function of the command is the same with or without the square bracketed items, as shown below. For example, for the query:

[SENSE:]UNIT?

Both SENSE:UNIT? and UNIT? are valid forms.

Command Format

CONFigure:VOLTage:DC 500

1 2 3

- 1. Command header
- 2. Space
- 3. Parameter 1

Common Input Parameters	Type	Description	Example
	<Boolean>	boolean logic	0, 1
	<NR1>	integers	0, 1, 2, 3
	<NR2>	decimal numbers	0.1, 3.14, 8.5
	<NR3>	floating point with exponent	4.5e-1, 8.25e+1
	<NRf>	any of NR1, 2, 3	1, 1.5, 4.5e-1
	[MIN] (Optional parameter)	For commands, this will set the setting to the lowest value. This parameter can be used in place of any numerical parameter where indicated. For queries, it will return the lowest possible value allowed for the particular setting.	
	[MAX] (Optional parameter)	For commands, this will set the setting to the default value. This parameter can be used in place of any numerical parameter where indicated. For queries, it will return the highest possible value allowed for the particular setting.	
	DEF	For commands, this will set the setting to the default value. This parameter can be used in place of any numerical parameter where indicated. For queries, it will return the default value allowed for the particular setting.	
Automatic parameter range selection	The GDM-9041/9042 automatically sets the command parameter to the next available value.		

	Example	conf:volt:dc 5	
		This will set the measurement item to DC Voltage and the range to 5V. There is no 1V range so the DMM selects the next available range, 5V.	
Message Terminator (EOL)	Remote Command	Marks the end of a command line. The following messages are in accordance with IEEE488.2 standard.	
		LF, CR, CR+LF	The most common EOL character is CR+LF
		LF+CR	
Message Separator	EOL or ; (semicolon)	Command Separator	

Command Set

Configure Commands (1st)

CONFigure:VOLTage:DC.....	124
CONFigure:VOLTage:AC.....	124
CONFigure:CURRent:DC.....	124
CONFigure:CURRent:AC.....	124
CONFigure:RESistance.....	124
CONFigure:FREQuency.....	124
CONFigure:PERiod.....	124
CONFigure:CONTInuity.....	125
CONFigure:DIODE.....	125
CONFigure:TEMPerature:TCouple.....	125
CONFigure:CAPacitance.....	125
CONFigure:FUNCTion?.....	125
CONFigure:RANGe?.....	125
CONFigure:AUTO.....	125
CONFigure:AUTO?.....	125

Configure Commands (2nd)

CONFigure2:VOLTage:DC.....	126
CONFigure2:VOLTage:AC.....	126
CONFigure2:CURRent:DC.....	126
CONFigure2:CURRent:AC.....	126
CONFigure2:RESistance.....	126
CONFigure2:FREQuency.....	126
CONFigure2:PERiod.....	126
CONFigure2:OFF.....	127
CONFigure2:FUNCTion?.....	127
CONFigure2:RANGe?.....	127
CONFigure2:AUTO.....	127
CONFigure2:AUTO?.....	127

Measure Commands

MEASure:VOLTage:DC?	128
MEASure:VOLTage:AC?	128
MEASure:CURRent:DC?	128
MEASure:CURRent:AC?	128
MEASure:RESistance?	129
MEASure:FREQuency?	129
MEASure:PERiod?	129
MEASure:CONTInuity?	129
MEASure:DIODE?	129
MEASure:TEMPerature:TCouple?	129
MEASure:CAPacitance?	129
MEASure2:VOLTage:DC?	130
MEASure2:VOLTage:AC?	130
MEASure2:CURRent:DC?	130
MEASure2:CURRent:AC?	130
MEASure2:RESistance?	130
MEASure2:FREQuency?	130
MEASure2:PERiod?	130

Sense Commands

[SENSe:]TEMPerature:TCouple:TYPE	131
[SENSe:]TEMPerature:TCouple:TYPE?	131
[SENSe:]TEMPerature:RJUNction:SIMulated	131
[SENSe:]TEMPerature:RJUNction:SIMulated?	131
[SENSe:]DETEctor:RATE	131
[SENSe:]DETEctor:RATE?	131
[SENSe:]FREQuency:INPutjack	131
[SENSe:]FREQuency:INPutjack?	131
[SENSe:]PERiod:INPutjack	131
[SENSe:]PERiod:INPutjack?	132
[SENSe:]CONTInuity:THReshold	132
[SENSe:]CONTInuity:THReshold?	132
[SENSe:]UNIT	132
[SENSe:]UNIT?	132

[SENSe:]FUNctIon[X].....	132
[SENSe:]FUNctIon[X]?.....	132
[SENSe:]DATA?.....	132
[SENSe:]CAPacitance:CABLe:CALibration.....	133
[SENSe:]VOLTage:DC:IMPedance:AUTO.....	133
[SENSe:]VOLTage:DC:IMPedance:AUTO?.....	133
[SENSe:]FILTer:COUNT.....	133
[SENSe:]FILTer:COUNT?.....	133
[SENSe:]FILTer:STATe.....	133
[SENSe:]FILTer:STATe?.....	133
[SENSe:]FILTer:TCONtrol.....	133
[SENSe:]FILTer:TCONtrol?.....	133
[SENSe:]FILTer:WINDow.....	134
[SENSe:]FILTer:WINDow?.....	134

Calculate Commands

CALCulate:FUNctIon.....	135
CALCulate:FUNctIon?.....	135
CALCulate:STATe.....	135
CALCulate:STATe?.....	135
CALCulate:MINimum?.....	135
CALCulate:MAXimum?.....	135
CALCulate:HOLD:REFerence.....	135
CALCulate:HOLD:REFerence?.....	135
CALCulate:REL:REFerence.....	135
CALCulate:REL:REFerence?.....	135
CALCulate:LIMit:LOWer.....	136
CALCulate:LIMit:LOWer?.....	136
CALCulate:LIMit:UPPer.....	136
CALCulate:LIMit:UPPer?.....	136
CALCulate:LIMit:BEEPer:MODE.....	136
CALCulate:LIMit:BEEPer:MODE?.....	136
CALCulate:DB:REFerence.....	136
CALCulate:DB:REFerence?.....	136
CALCulate:DB:REFerence:METHod.....	136
CALCulate:DB:REFerence:METHod?.....	136
CALCulate:DBM:REFerence.....	137

CALCulate:DBM:REFeRence?	137
CALCulate:MATH:MMFactor	137
CALCulate:MATH:MMFactor?	137
CALCulate:MATH:MBFactor	137
CALCulate:MATH:MBFactor?	137
CALCulate:MATH:PERCent	137
CALCulate:MATH:PERCent?	137

Trigger Commands

READ?	138
VAL1?	138
VAL2?	138
TRIGger:SOURce	138
TRIGger:SOURce?	138
TRIGger:AUTO	138
TRIGger:AUTO?	138
SAMPlE:COUNT	138
SAMPlE:COUNT?	139
TRIGger:COUNT	139
TRIGger:COUNT?	139

Display Commands

DISPlay[:STATe]	140
DISPlay[:STATe]?	140
DISPlay:TEXT:CLEAr	140
DISPlay:TEXT[:DATA]	140
DISPlay:TEXT[:DATA]?	140

System Commands

SYSTem:BEEPer:STATe	141
SYSTem:BEEPer:STATe?	141
SYSTem:BEEPer:ERRor	141
SYSTem:BEEPer:ERRor?	141

SYSTem:BEEPer:COMPare:VOLume	141
SYSTem:BEEPer:COMPare:VOLume?.....	141
SYSTem:BEEPer:CONTInuity:VOLume	141
SYSTem:BEEPer:CONTInuity:VOLume?	141
SYSTem:BEEPer:HOLD:VOLume	141
SYSTem:BEEPer:HOLD:VOLume?.....	142
SYSTem:CLICk:STATe	142
SYSTem:CLICk:STATe?	142
SYSTem:DATE.....	142
SYSTem:DATE?	142
SYSTem:DISPlay	142
SYSTem:DISPlay?	142
SYSTem:ERRor?	142
SYSTem:SCPi:MODE.....	142
SYSTem:SCPi:MODE?.....	142
SYSTem:SERial?	143
SYSTem:TIME.....	143
SYSTem:TIME?	143
SYSTem:UPTime?	143
SYSTem:VERSiOn?.....	143

Status Commands

STATus:QUEStionable:ENABle	144
STATus:QUEStionable:ENABle?	144
STATus:QUEStionable:EVENT?	144
STATus:PRESet	144

Interface Commands

SYSTem:LOCal.....	144
SYSTem:REMote	144
SYSTem:RWLock.....	144

Common Command

*CLS	145
*ESE?	145
*ESE	145
*ESR?	145
*IDN?	145
*OPC?	145
*OPC	145
*PSC?	145
*PSC	145
*RST	145
*SRE?	146
*SRE	146
*STB?	146
*TRG	146

CONFigure Commands (1st)

CONFigure:VOLTage:DC

Sets measurement to DC Voltage on the 1st display and specifies the range.

Parameter: [None] | [Range(<NRf> | MIN | MAX | DEF)]

Example: CONF:VOLT:DC 5

Sets the voltage range to 5 volts.

CONFigure:VOLTage:AC

Sets measurement to AC Voltage on the 1st display and specifies the range.

Parameter: [None] | [Range(<NRf> | MIN | MAX | DEF)]

Example: CONF:VOLT:AC

Sets the AC range to auto range.

CONFigure:CURREnt:DC

Sets measurement to DC Current on the 1st display and specifies the range.

Parameter: [None] | [Range(<NRf> | MIN | MAX | DEF)]

Example: CONF:CURR:DC 50e-3

Sets the DC current range to 50mA.

CONFigure:CURREnt:AC

Sets measurement to AC Current on the 1st display and specifies range.

Parameter: [None] | [Range(<NRf> | MIN | MAX | DEF)]

Example: CONF:CURR:AC 50e-2

Sets the measurement mode to ACI with a 500mA range.

CONFigure:RESistance

Sets measurement to 2W Resistance on the 1st display and specifies range.

Parameter: [None] | [Range(<NRf> | MIN | MAX | DEF)]

Example: CONF:RES 50e3

Sets the range to 50k Ω .

CONFigure:FREQuency

Sets measurement to Frequency on the 1st display and specifies the range.

Parameter: [None] | [Range(<NRf> | MIN | MAX | DEF)]

Example: CONF:FREQ MAX

Sets the frequency measurement range to max.

CONFigure:PERiod

Sets measurement to Period on the 1st display and specifies the range.

Parameter: [None] | [Range(<NRf> | MIN | MAX | DEF)]

Example: CONF:PER

Sets the DMM to period measurement using the previous range.

CONFigure:CONTInuity

Sets measurement to Continuity on the 1st display.

Parameter: None

CONFigure:DIODe

Sets measurement to Diode on the 1st display.

Parameter: None

CONFigure:TEMPerature:TCouple

Sets measurement to Temperature thermocouple (T-CUP) on the 1st display.

Parameter: [None] | [Type(J | K | T)]

Example: CONF:TEMP:TCO J

Sets the measurement mode to TCO with a type J sensor.

CONFigure:CAPacitance

Sets measurement to Capacitance on the 1st display.

Parameter: [None] | [Range(<NRf> | MIN | MAX | DEF)]

Example: CONF:CAP 5E-5

Sets the measurement mode to Capacitance with a 50 μ F Range.

CONFigure:FUNcTION?

Returns the current function on the 1st display.

Return parameter: VOLT, VOLT:AC, CURR, CURR:AC, RES, FREQ, PER, TEMP, DIOD, CONT, CAP

CONFigure:RANGe?

Returns the current range on the 1st display.

Return Parameter:

DCV: 0.5(500mV), 5(5V), 50(50V), 500(500V), 1000(1000V)

ACV: 0.5(500mV), 5(5V), 50(50V), 500(500V), 750(750V)

DCI: 0.0005(500 μ A), 0.005 (5mA), 0.05(50mA), 0.5(500mA), 5(5A), 10(10A)

ACI: 0.0005(500 μ A), 0.005 (5mA), 0.05(50mA), 0.5(500mA), 5(5A), 10(10A)

RES: 50E+1(500 Ω), 50E+2(5k Ω), 50E+3(50k Ω), 50E+4 (500k Ω), 50E+5(5M Ω), 10E+7(100M Ω)

CAP: 5E-9(5nF), 5E-8(50nF), 5E-7(500nF), 5E-6(5 μ F), 5E-5(50 μ F)

CONFigure:AUTO

Sets Auto-Range on or off on the 1st display.

Parameter: 0 | 1 | ON | OFF

Example: CONF:AUTO ON

CONFigure:AUTO?

Returns the Auto-Range status of the function on the 1st display.

Return Parameter: 0 | 1, 1=Auto range, 0=Manual range

CONFigure2 Command (2nd)

CONFigure2:VOLTage:DC

Sets measurement to DC Voltage on the 2nd display and specifies the range.

Parameter: [None] | [Range(<NRf> | MIN | MAX | DEF)]

Example: CONF2:VOLT:DC 5

Sets the voltage range to 5 volts.

CONFigure2:VOLTage:AC

Sets measurement to AC Voltage on the 2nd display and specifies the range.

Parameter: [None] | [Range(<NRf> | MIN | MAX | DEF)]

Example: CONF2:VOLT:AC

Sets the measurement mode to AC voltage.

CONFigure2:CURRent:DC

Sets measurement to DC Current on the 2nd display and specifies the range.

Parameter: [None] | [Range(<NRf> | MIN | MAX | DEF)]

Example: CONF2:CURR:DC 50e-3

Sets the DC current range to 50mA on the second display.

CONFigure2:CURRent:AC

Sets measurement to AC Current on the 2nd display and specifies the range.

Parameter: [None] | [Range(<NRf> | MIN | MAX | DEF)]

Example: CONF2:CURR:AC 50e-2

Sets the measurement mode to ACI with a 500mA range on the second display.

CONFigure2:RESistance

Sets measurement to 2W Resistance on the 2nd display and specifies the range.

Parameter: [None] | [Range(<NRf> | MIN | MAX | DEF)]

Example: CONF2:RES 50e3

Sets the range to 50kΩ on the second display.

CONFigure2:FREQuency

Sets measurement to Frequency on the 2nd display and specifies the range.

Parameter: [None] | [Range(<NRf> | MIN | MAX | DEF)]

Example: CONF2:FREQ MAX

Sets the frequency measurement range to max on the second display.

CONFigure2:PERiod

Sets measurement to Period on the 2nd display and specifies the range.

Parameter: [None] | [Range(<NRf> | MIN | MAX | DEF)]

Example: CONF2:PER

Sets the DMM to period measurement using the previous range.

CONFigure2:OFF

Turns the 2nd display function off.

Parameter: None.

CONFigure2:FUNCTION?

Returns the current function on the 2nd display.

Return parameter: VOLT, VOLT:AC, CURR, CURR:AC, RES, FREQ, PER, NON

CONFigure2:RANGE?

Returns the range of the current function on the 2nd display.

Return parameter:

DCV: 0.5(500mV), 5(5V), 50(50V), 500(500V), 1000(1000V)

ACV: 0.5(500mV), 5(5V), 50(50V), 500(500V), 750(750V)

DCI: 0.0005(500μA), 0.005 (5mA), 0.05(50mA), 0.5(500mA), 5(5A), 10(10A)

ACI: 0.0005(500μA), 0.005 (5mA), 0.05(50mA), 0.5(500mA), 5(5A), 10(10A)

RES: 50E+1(500Ω) 50E+2(5kΩ), 50E+3(50kΩ), 50E+4(500kΩ), 50E+5(5MΩ), 10E+7(100MΩ)

CONFigure2:AUTO

Sets Auto-Range on or off on the 2nd display.

Parameter: 0 | 1 | ON | OFF

Example: CONF2:AUTO ON

CONFigure2:AUTO?

Returns the Auto-Range status of the function on the 2nd display.

Return Parameter: 0|1, 1=Auto range, 0=Manual range

Measure Commands

MEASure:VOLTage:DC?

Returns the DC voltage measurement on the 1st display.

Parameter: [None] | [Range(<NRf> | MIN | MAX | DEF)]

Example: MEAS:VOLT:DC?

> +0.4880E-04

Returns the DC voltage measurement as 0.0488 mV.

MEASure:VOLTage:AC?

Returns the AC voltage measurement on the 1st display.

Parameter: [None] | [Range(<NRf> | MIN | MAX | DEF)]

Example: MEAS:VOLT:AC?

> +0.5110E-03

Returns the AC voltage measurement as 0.511 mV.

MEASure:CURRent:DC?

Returns the DC current measurement on the 1st display.

Parameter: [None] | [Range(<NRf> | MIN | MAX | DEF)]

Example: MEAS:CURR:DC?

> +0.2340E-04

Returns the DC current measurement as 0.0234 mA.

MEASure:CURRent:AC?

Returns the AC current measurement on the 1st display.

Parameter: [None] | [Range(<NRf> | MIN | MAX | DEF)]

Example: MEAS:CURR:AC?

> +1.3872E-02

Returns the AC current measurement as 13.872 mA.

MEASure:RESistance?

Returns the 2W resistance measurement on the 1st display.

Parameter: [None] | [Range(<NRf> | MIN | MAX | DEF)]

Example: MEAS:RES?

> +1.1937E+03

Returns the 2W measurement as 1.1937 kΩ.

MEASure:FREQUency?

Returns the frequency measurement on the 1st display.

Parameter: [None] | [Range(<NRf> | MIN | MAX | DEF)]

Example: MEAS:FREQ?

> +2.3708E+02

Returns the frequency (237.08 Hz).

MEASure:PERiod?

Returns the period measurement on the 1st display.

Parameter: [None] | [Range(<NRf> | MIN | MAX | DEF)]

Example: MEAS:PER? MAX

Returns the period at the maximum range.

MEASure:CONTInuity?

Returns the continuity measurement on the 1st display.

Example: MEAS:CONT?

Returns the continuity.

MEASure:DIODE?

Returns the diode measurement on the 1st display.

Example: MEAS:DIOD?

Returns the diode measurement.

MEASure:TEMPerature:TCouple?

Returns the temperature for the selected thermocouple type on the 1st display.

Parameter:[NONE] | J | K | T

Example: MEAS:TEMP:TCO? J

> +2.5000E+01

Returns the temperature.

MEASure:CAPacitance?

Returns the capacitance measurement on the 1st display.

Parameter: [None] | [Range(<NRf> | MIN | MAX | DEF)]

Example: MEAS:CAP?

Returns the capacitance measurement.

MEASure2:VOLTage:DC?

Returns the DC voltage measurement on the 2nd display.

Parameter: [None] | [Range(<NRf> | MIN | MAX | DEF)]

Example: MEAS2:VOLT:DC?

> +0.4880E-04

Returns the DC voltage measurement as 0.0488 mV.

MEASure2:VOLTage:AC?

Returns the AC voltage measurement on the 2nd display.

Parameter: [None] | [Range(<NRf> | MIN | MAX | DEF)]

Example: MEAS2:VOLT:AC?

> +0.5110E-03

Returns the AC voltage measurement as 0.511 mV.

MEASure2:CURRent:DC?

Returns the DC current measurement on the 2nd display.

Parameter: [None] | [Range(<NRf> | MIN | MAX | DEF)]

Example: MEAS2:CURR:DC?

> +0.2340E-04

Returns the DC current measurement as 0.0234 mA.

MEASure2:CURRent:AC?

Returns the AC current measurement on the 2nd display.

Parameter: [None] | [Range(<NRf> | MIN | MAX | DEF)]

Example: MEAS2:CURR:AC?

> +0.3870E-02

Returns the AC current measurement as 3.87 mA.

MEASure2:RESistance?

Returns the 2W resistance measurement on the 2nd display.

Parameter: [None] | [Range(<NRf> | MIN | MAX | DEF)]

Example: MEAS2:RES?

> +1.1912E+03

Returns the 2W measurement as 1.1912 kΩ.

MEASure2:FREQuency?

Returns the frequency measurement on the 2nd display.

Parameter: [None] | [Range(<NRf> | MIN | MAX | DEF)]

Example: MEAS2:FREQ?

> +2.3712E+02

Returns the frequency (237.12 Hz).

MEASure2:PERiod?

Returns the period measurement on the 2nd display.

Parameter: [None] | [Range(<NRf> | MIN | MAX | DEF)]

Example: MEAS2:PER? MAX

Returns the period at the maximum range.

SENSe Commands

[SENSe:]TEMPerature:TCouple:TYPE

Sets thermocouple type.

Parameter: Type(J | K | T)

Example: SENS:TEMP:TCO:TYPE J

Sets the thermocouple to type J.

[SENSe:]TEMPerature:TCouple:TYPE?

Returns the thermocouple type.

Return parameter: J, K, T

[SENSe:]TEMPerature:RJUNction:SIMulated

Set temperature simulation value.

Parameter: <NRf>(0.00 to 50.00)

Example: SENS:TEMP:RJUN:SIM 25.00

Sets the thermocouple junction temperature to 25°C.

[SENSe:]TEMPerature:RJUNction:SIMulated?

Returns temperature simulation value.

Return parameter: <NR1> (+0000 to +5000) ,where +0000=0.00°C, +5000=50.00°C

[SENSe:]DETEctor:RATE

Sets the detection rate (sample rate)

Parameter: RATE(S | M | F)

Example: SENS:DET:RATE S

Sets the rate to slow (S).

[SENSe:]DETEctor:RATE?

Returns the sample rate.

Return parameter: SLOW, MID, FAST

[SENSe:]FREQuency:INPutjack

Assigns an input terminal for the frequency function.

Parameter: (0 | 1 | 2) 0=volt, 1=500mA, 2=10A

Example: SENS:FREQ:INP 0

Sets the input jack to the Volt input terminal.

[SENSe:]FREQuency:INPutjack?

Returns the assigned input terminal used for the frequency function.

Return Parameter: VOLT, 500mA, 10A

[SENSe:]PERiod:INPutjack

Assigns an input terminal for the period function.

Parameter: (0 | 1 | 2) 0=volt, 1=500mA, 2=10A

Example: SENS:PER:INP 0

Sets the input jack to the Volt input terminal.

[SENSe:]PERiod:INPutjack?

Returns the assigned input terminal used for the period function.

Return Parameter: VOLT, 500mA, 10A

[SENSe:]CONTInuity:THReshold

Sets the continuity threshold in ohms.

Parameter: <NR1> (0 to 1000)

Example: SENS:CONT:THR 500

Sets the continuity threshold to 500Ω

[SENSe:]CONTInuity:THReshold?

Returns the continuity threshold.

[SENSe:]UNIT

Sets the temperature unit.

Parameter: C|F

Example: SENS:UNIT C

Sets the temperature unit to °C.

[SENSe:]UNIT?

Returns the temperature unit.

[SENSe:]FUNCTion[X]

Sets the function for the 1st or 2nd display, which X = 1 indicate 1st display, X = 2 indicate 2nd display.

Parameter:

(1st): "VOLT[:DC]", "VOLT:AC", "CURR[:DC]", "CURR:AC", "RES", "FRES", "FREQ", "PER", "TEMP:TCO", "DIOD", "CONT", "CAP"

(2nd): "VOLT[:DC]", "VOLT:AC", "CURR[:DC]", "CURR:AC", "RES", "FRES", "FREQ", "PER", "NON"

Example: SENS:FUNC1 "VOLT:DC"

Sets the 1st display to the DCV function.

[SENSe:]FUNCTion[X]?

Returns the function for the 1st or 2nd display, which X = 1 indicate 1st display, X = 2 indicate 2nd display.

Return parameter:

(1st): VOLT, VOLT:AC, CURR, CURR:AC, RES, FRES, FREQ, PER, TEMP:TCO, DIOD, CONT, CAP

(2nd): VOLT, VOLT:AC, CURR, CURR:AC, RES, FRES, FREQ, PER, NON

[SENSe:]DATA?

Returns the auxiliary measurement value.

[SENSe:]CAPacitance:CABLe:CALibration

It is used like Relative function before capacitance measurement, (only be used at range 5nF,50nF).

Parameter: [None]

Example: CONF:CAP 5e-9

SENS:CAP:CABL:CAL

Makes test lead to zero before capacitance measurement.

[SENSe:]VOLTage:DC:IMPedance:AUTO

Sets the Automatic input impedance for DC Voltage measurement.

Parameter: 0 | 1 | ON(10G) | OFF(10M)

Example: SENS:VOLT:DC:IMP:AUTO ON

Turns the Automatic input impedance on.

[SENSe:]VOLTage:DC:IMPedance:AUTO?

Returns the Automatic input impedance mode.

Return parameter: 0 | 1, 1=ON(10G), 0=OFF(10M)

[SENSe:]FILTer:COUNT

Sets the digital filter count.

Parameter: <NR1> (2 to 160) | MIN | MAX | DEF

Example: SENS:FILT:COUN 100

Sets digital filter count number to 100.

[SENSe:]FILTer:COUNT?

Returns the digital filter count.

Return parameter: <NR1>, Ex: +002

[SENSe:]FILTer:STATe

Turns the digital filter function On/Off.

Return parameter:

Parameter: 0 | 1 | ON | OFF

Example: SENS:FILT:STAT ON

Turns digital filter function on

[SENSe:]FILTer:STATe?

Returns the state of the digital filter function (on or off).

Return parameter: 0 | 1, 1=ON, 0=OFF

[SENSe:]FILTer:TCONtrol

Selects the digital filter type.

Parameter: MOV | REP

Example: SENS:FILT:TCON MOV

Sets digital filter type to the moving filter.

[SENSe:]FILTer:TCONtrol?

Returns the digital filter type.

Return parameter: MOV (moving) | REP (repeating)

[SENSe:]FILTeR:WINDow

Selects a digital filter window.

Parameters: 0.01 | 0.1 | 1 | 10 | NONE

Example: SENS:FILT:WIND 0.1

Sets digital filter window to 0.1%

[SENSe:]FILTeR:WINDow?

Returns the digital filter window value.

Return parameter: 0.01 | 0.1 | 1 | 10 | NONE

CALCulate Commands

CALCulate:FUNCTION

Sets the Advanced function.

Parameter: OFF | MIN | MAX | HOLD | REL | COMP | DB | DBM | MXB | INV | REF

Example: CALC:FUNC REL

Sets the Advanced function to REL (relative)

CALCulate:FUNCTION?

Returns the current Advanced function.

CALCulate:STATe

Turns the Advanced function on/off.

Parameter: 0 | 1 | ON | OFF

Example: CALC:STAT OFF

Turns the Advanced function off.

CALCulate:STATe?

Returns the status of the Advanced function.

Return Parameter: 0 | 1, 1=ON, 0=OFF

CALCulate:MINimum?

Returns the minimum value from the Max/Min measurement.

CALCulate:MAXimum?

Returns the maximum value from the Max/Min measurement.

CALCulate:HOLD:REFerence

Sets the percentage threshold for the Hold function.

Parameter: <NRf> (0.01, 0.1, 1, 10)

Example: CALC:HOLD:REF 10

Sets the hold percentage to 10%.

CALCulate:HOLD:REFerence?

Returns the percentage threshold from the Hold function.

CALCulate:REL:REFerence

Sets the reference value for the relative function.

Parameter: <NRf> | MIN | MAX

Example: CALC:REL:REF MAX

Sets the reference value to the maximum allowed.

CALCulate:REL:REFerence?

Returns the reference value from the relative function.

CALCulate:LIMit:LOWer

Sets the lower limit of the compare function.

Parameter: <NRf> | MIN | MAX

Example: CALC:LIM:LOW 1.0

Sets the lower limit to 1.0

CALCulate:LIMit:LOWer?

Returns the lower limit of the compare function.

CALCulate:LIMit:UPPer

Sets the upper limit of the compare function.

Parameter: <NRf> | MIN | MAX

Example: CALC:LIM:UPP 1.0

Sets the upper limit to 1.0

CALCulate:LIMit:UPPer?

Returns the upper limit of the compare function.

CALCulate:LIMit:BEEPer:MODE

Sets the beeper alarm mode of the compare function.

Parameter: <NR1> (0 to 2) 0(OFF), 1(PASS), 2(FAIL)

Example: CALC:LIM:BEEP:MODE PASS

Sets the pass alarm to compare function.

CALCulate:LIMit:BEEPer:MODE?

Returns the beeper alarm mode of the compare function.

Return Parameter: OFF | PASS | FAIL

CALCulate:DB:REFerence

Sets the reference value for the dB function.

Parameter: <NRf> | MIN | MAX

Example: CALC:DB:REF MAX

Sets the reference voltage for dB measurements to the maximum allowed.

CALCulate:DB:REFerence?

Returns the reference voltage from the dB function.

CALCulate:DB:REFerence:METHod

Sets the unit of reference value for the dB function.

Parameter: VOLTage | DBM

Example: CALC:DB:REF:METH DBM

Sets the unit to dbm of reference value for dB function.

CALCulate:DB:REFerence:METHod?

Returns the unit of reference value from the dB function.

Return parameter: Voltage | dBm

CALCulate:DBM:REference

Sets the resistance value for the dBm function.

Parameter: <NR1> (2, 4, 8, 16, 50, 75, 93, 110, 124, 125, 135, 150, 250, 300, 500, 600, 800, 900, 1000, 1200, 8000) | MIN | MAX | DEF

Example: CALC:DBM:REF MAX

Sets the resistance value for dBm measurements to the maximum allowed.

CALCulate:DBM:REference?

Returns the resistance value from the dBm function.

CALCulate:MATH:MMFactor

Sets the scale factor M for math measurements.

Parameter: <NRf> | MIN | MAX

Example: CALC:MATH:MMF MIN

Sets the scale factor M to the minimum allowed value.

CALCulate:MATH:MMFactor?

Returns the scale factor M used in the math measurement.

CALCulate:MATH:MBFactor

Sets the offset factor B for math measurements.

Parameter: <NRf> | MIN | MAX

Example: CALC:MATH:MBF MIN

Sets the offset factor B to the minimum allowed value.

CALCulate:MATH:MBFactor?

Returns the offset factor B used in the math measurement.

CALCulate:MATH:PERCent

Sets the reference value for the Percent function.

Parameter: <NRf> | MIN | MAX

Example: CALC:MATH:PERC MAX

Sets the reference value for the Percent function to the maximum.

CALCulate:MATH:PERCent?

Returns the reference value setting for the Percent function.

TRIGger Commands

READ?

Returns 1st and 2nd display value.

VAL1?

Returns the 1st display reading

Example: SAMP:COUN 100

VAL1?

>+0.3331E-04,

>+0.3892E-04,

> etc, for 100 counts.

Queries 100 counts of stored samples from the 1st display.

VAL2?

Returns the 2nd display reading.

Example: SAMP:COUN 100

VAL2?

>+0.3453E-04,

>+0.3918E-04,

> etc, for 100 counts.

Queries 100 counts of stored samples from the 2nd display.

TRIGger:SOURce

Selects the trigger source.

Parameter: INT | SIN

Example: TRIG:SOUR INT

Sets the trigger source as internal.

TRIGger:SOURce?

Returns current trigger source.

TRIGger:AUTO

Turns Trigger Auto mode on/off.

Parameters: 0 | 1 | ON | OFF

Example: TRIG:AUTO OFF

Turns the Trigger Auto mode off.

TRIGger:AUTO?

Returns the Trigger Auto mode.

Return parameter: 0 | 1, 1=ON, 0=OFF

SAMPle:COUNT

Sets the number of samples.

Parameter: <NR1>(1 to 9999) | MIN | MAX

Example: SAMP:COUN 10

Sets the number of samples to 10.

SAMPlE:COUNT?

Returns the number of samples.

TRIGger:COUNT

Sets the number of trigger counts.

Parameter: <NR1>(1 to 9999) | MIN | MAX

Example: TRIG:COUN 10

Sets the number of trigger counts to 10.

TRIGger:COUNT?

Returns the number of trigger counts.

DISPlay Commands

DISPlay[:STATe]

Sets TFT LCD display screen on/off.

Parameter: 0 | 1 | ON | OFF

Example: DISP OFF

Turns the TFT LCD display screen OFF.

DISPlay[:STATe]?

Returns the TFT LCD display screen state.

Return parameter: 0 | 1, 1=ON, 0=OFF

DISPlay:TEXT:CLEAr

Clears the text message from the display.

- With DISP:STAT ON, DISP:TEXT:CLE returns the display to its normal mode.
 - With DISP:STAT OFF, DISP:TEXT:CLE clears the message and the display remains disabled. To enable the display, send DISPlay ON or press the front panel Shift key(Local).
-

DISPlay:TEXT[:DATA]

Sets the text message to TFT LCD display screen.

Parameter: "<message>", max length = 15 characters

Example: DISP:TEXT:DATA "testing"

Prints the testing characters to TFT LCD display screen.

DISPlay:TEXT[:DATA]?

Returns the text message of TFT LCD display screen.

Return parameter: "<message>", Ex: "testing".

SYSTEM Related Commands

SYSTEM:BEEPer:STATE

Turns the buzzer on/off.

Parameter: 0 | 1 | ON | OFF

Example: SYST:BEEP:STAT 0

Turns the buzzer off.

SYSTEM:BEEPer:STATE?

Returns the buzzer state.

Return parameter: 0|1, 1=ON, 0=OFF

SYSTEM:BEEPer:ERRor

Sets the beeper to sound on an SCPI error.

Parameter: 0 | 1 | ON | OFF

Example: SYST:BEEP:ERR ON

Allows the beeper to sound when an SCPI error occurs.

SYSTEM:BEEPer:ERRor?

Returns the beeper error mode.

Return parameter: 0|1, 1=ON, 0=OFF

SYSTEM:BEEPer:COMPare:VOLume

Sets the beeper volume of Compare function.

Parameter: <NR1> (0 to 2) 0(Small), 1(Medium), 2(Large)

Example: SYST:BEEP:COMP:VOL 2

Sets the beeper volume to large of Compare function.

SYSTEM:BEEPer:COMPare:VOLume?

Returns the beeper volume of Compare function.

Return parameter: SMALL | MEDIUM | LARGE

SYSTEM:BEEPer:CONTInuity:VOLume

Sets the beeper volume of Continuity function.

Parameter: <NR1> (0 to 3) 0(Off), 1(Small), 2(Medium), 3(Large)

Example: SYST:BEEP:CONT:VOL 1

Sets the beeper volume to small of Continuity function.

SYSTEM:BEEPer:CONTInuity:VOLume?

Returns the beeper volume of Continuity function.

Return parameter: OFF | SMALL | MEDIUM | LARGE

SYSTEM:BEEPer:HOLD:VOLume

Sets the beeper volume of Hold function.

Parameter: <NR1> (0 to 3) 0(Off), 1(Small), 2(Medium), 3(Large)

Example: SYST:BEEP:HOLD:VOL 2

Sets the beeper volume to medium of Hold function.

SYSTem:BEEPer:HOLD:VOLume?

Returns the beeper volume of Hold function.

Return parameter: OFF | SMALL | MEDIUM | LARGE

SYSTem:CLICK:STATE

Turns the key sound of front panel on/off.

Parameter: 0 | 1 | ON | OFF

Example: SYST:CLIC:STAT 0

Turns key sound off.

SYSTem:CLICK:STATE?

Returns the key sound of front panel state.

Return parameter: 0|1, 1=ON, 0=OFF

SYSTem:DATE

Sets the date for the instrument's real-time clock.

Parameter: <NR1> (year, month, day)

Example: SYST:DATE 2025,02,25

Sets the date to 2025/2/25.

year: 2000 to 2099

month: 1 to 12

day: 1 to 31.

SYSTem:DATE?

Returns system date.

Return parameter: <Date>, Ex: 2025,2,25

SYSTem:DISPlay

Turns the Display on/off.

Parameter: 0 | 1 | ON | OFF

Example: SYST:DISP ON

Turns the display on.

SYSTem:DISPlay?

Returns the status of the display

Return parameter: 0|1, 1=ON, 0=OFF

SYSTem:ERRor?

Returns the current system error, if any.

SYSTem:SCPi:MODE

Sets the SCPI mode.

Parameter: NORM | COMP

(NORM=Normal, COMP= Compatible to GDM834X)

Example: SYST:SCP:MODE NORM

Sets the SCPI mode to normal.

SYSTem:SCPi:MODE?

Returns the SCPI mode.

Return parameter: NORMAL | COMPATIBLE

SYSTem:SERial?

Returns the serial number (nine characters/ numbers)

SYSTem:TIME

Sets the time for the instrument's real-time clock.

Parameter: <NR1> (hour, minute, second)

Example: SYST:TIME 16,20,30

Sets the time to 16:20:30

hour: 0 to 23

minute: 0 to 59

second: 0 to 59

SYSTem:TIME?

Returns system time.

Return parameter: <Time>, Ex: 16:20:40

SYSTem:UPTime?

Returns the amount of time that the instrument has been running since the last power-on.

Return parameter: +0, +1, +25, +53 (day, hour, minute, second)

SYSTem:VERSion?

Returns SCPI version.

Return parameter: 1994.0.

STATus Report Commands

STATus:QUESTionable:ENABLE

Set bits in the Questionable Data Enable register.

STATus:QUESTionable:ENABLE?

Returns the contents of the Questionable Data Enable register.

STATus:QUESTionable:EVENT?

Returns the contents of the Questionable Data Event register.

STATus:PRESet

Clears the Questionable Data Enable register.

Example: STAT:PRES

Interface Commands

SYSTEM:LOCAL

Enables local control (front panel control) and disables remote control.

SYSTEM:REMOte

Enables remote control and disables local control (front panel control, all key are disable except Shift key(return to local control)).

SYSTEM:RWLock

Enables remote control and disables local control (front panel control, all key are disable).The only way to return local mode is to issue the SYSTEM:LOCAL command.

IEEE 488.2 Common Commands

*CLS

Clears the Event Status register (Output Queue, Operation Event Status, Questionable Event Status, Standard Event Status)

*ESE?

Returns the ESER (Event Status Enable Register) contents.

Example: *ESE?

>130

Returns 130. ESER=10000010

*ESE

Sets the ESER contents.

Parameter: <NR1> (0 to 255)

Example: *ESE 65

Sets the ESER to 01000001

*ESR?

Returns SESR (Standard Event Status Register) contents.

Example: *ESR?

>198

Returns 198. SESR=11000110

*IDN?

Returns the manufacturer, model No., serial number and system version number.

Example: *IDN?

>GWInstek,GDM-9042,000000000,1.00

*OPC?

"1" is placed in the output queue when all the pending operations are completed.

*OPC

Sets operation complete bit (bit0) in SERS (Standard Event Status Register) when all pending operations are completed.

*PSC?

Returns power On clear status.

Return parameter: <Boolean>(0 | 1) 0= don't clear, 1=clear

*PSC

Clears power On status.

Parameter: <Boolean>(0 | 1) 0=don't clear, 1= clear

*RST

Recalls default panel setup.

***SRE?**

Returns the SRER (Service Request Enable Register) contents.

***SRE**

Sets SRER contents.

Parameter: <NR1>(0 to 255)

Example: *SRE 7

Sets the SRER to 00000111.

***STB?**

Returns the SBR (Status Byte Register) contents.

Example:*STB?

>81

Returns the contents of the SBR as 01010001.

***TRG**

Manually triggers the DMM.

For the following command sets, please refer to the status system diagram on page 147.

STAT: QUES: EVEN?
STAT: QUES: ENAB
STAT: QUES: ENAB?
*ESR?
*ESE
*ESE?
*STB?
*SRE
*SRE?

**Note**

By sending the query command, STAT:QUES:EVEN?, user can obtain the judgements from Compare function as follows:

- When compare judgement is PASS, it returns "00000".
 - When compare judgement is High, it returns "04097".
 - When compare judgement is Low, it returns "02049".
-

Status system

The diagram below is a description of the status system

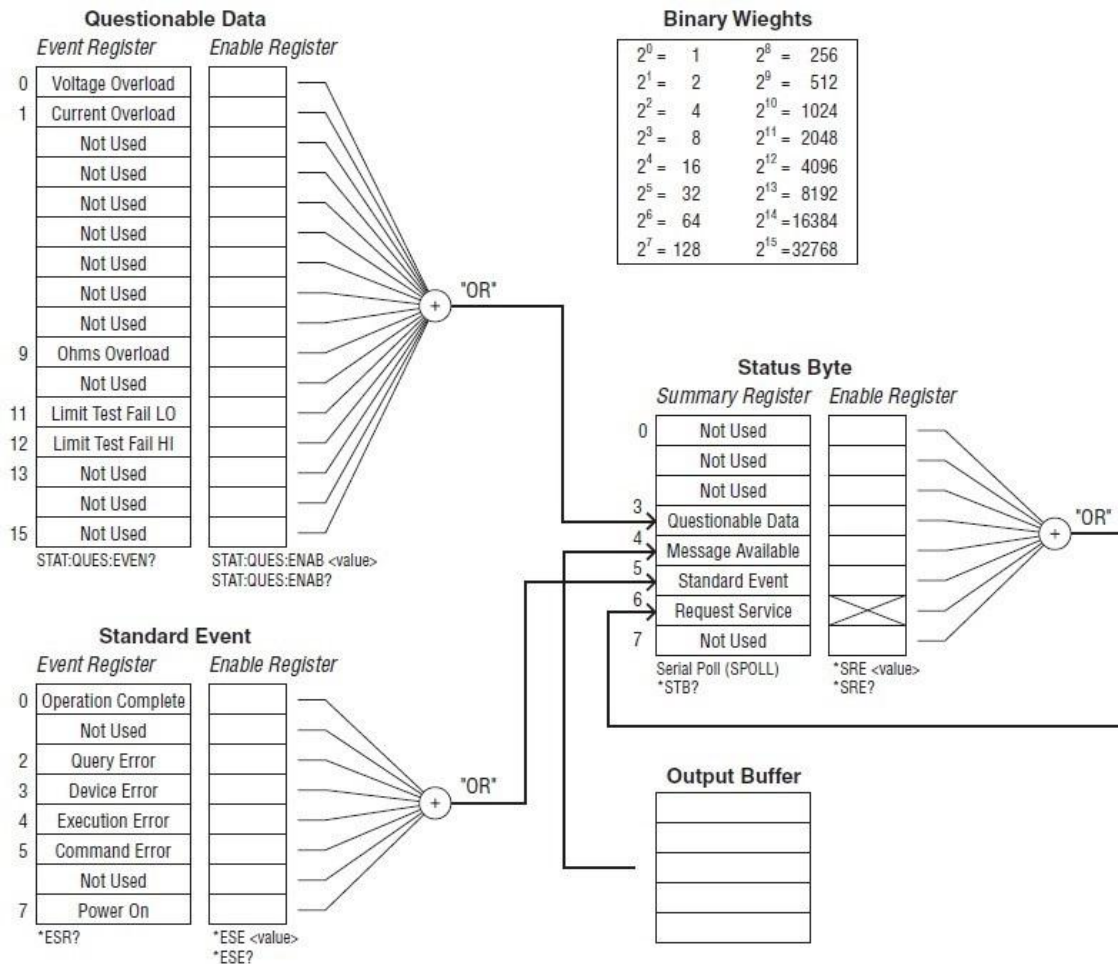

For the following command sets, please refer to the diagram above.

STAT:QUES:EVEN?

STAT:QUES:ENAB

STAT:QUES:ENAB?

*ESR?

*ESE

*ESE?

*STB?

*SRE

*SRE?

APPENDIX

Fuse Replacement.....	149
Replace AC Source Fuse.....	149
Replace 0.5A Input Current Fuse.....	150
Replace Internal 10A Input Current Fuse	151
Battery Replacement	153
Factory Default Parameters	155
Specifications	158
General Specifications.....	158
DC Voltage.....	159
DC Current.....	159
AC Voltage, ACV+DCV[3] (AC Coupled)	160
AC Current, ACI+DCI[3] (AC Coupled)	160
Resistance	161
Diode	161
Continuity.....	161
Capacitance	162
Frequency.....	162
Temperature Specifications	163
Dimensions.....	164
Declaration of Conformity	165

Fuse Replacement

Replace AC Source Fuse

Steps Remove the power cord followed by taking out the fuse box via using a small screw driver.

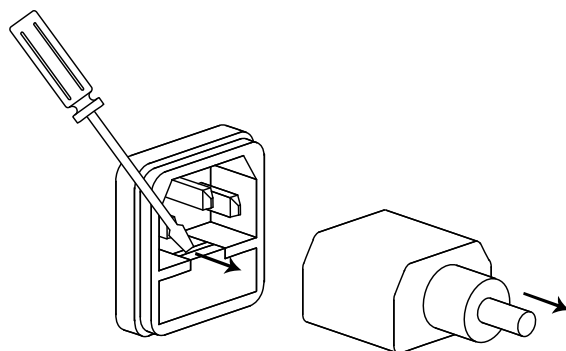

The AC source fuse is stored within the housing.

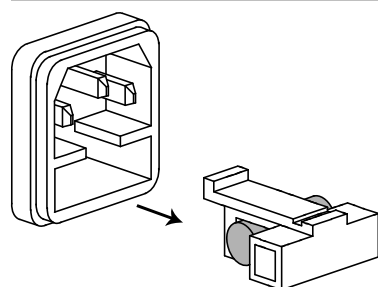

Rating

- 100/120 VAC: T 0.315 A
- 220/240 VAC: T 0.16 A

Replace 0.5A Input Current Fuse

Preparation To make sure if 0.5 A input current needs to be replaced, press the **•))** button to set GDM-9041/9042 in Continuity mode and short circuit the HI input terminal with the 0.5 A input current terminal.

If the test result shows OPEN, the fuse, which is accessible from the rear panel, requires replacement.

If the fuse of 0.5 A input current is damaged, please first check the one (1.0 A 1000 V) in the upper-left corner of rear panel.

- Step**
1. Turn the instrument off
 2. Remove the fuse cover by loosening the screw, and the fuse holder is shown accordingly.

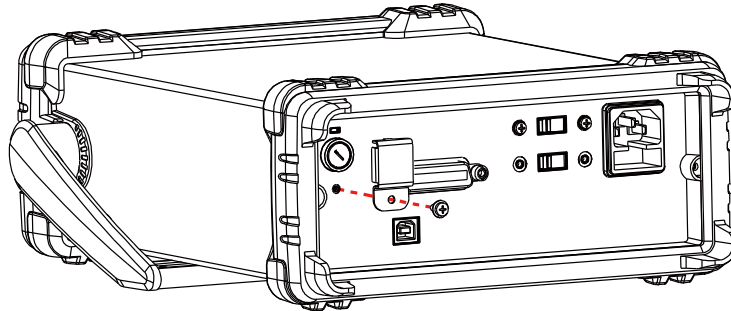

3. Press and hold the fuse holder in the rear panel followed by rotating it counterclockwise with a flat-blade screwdriver.

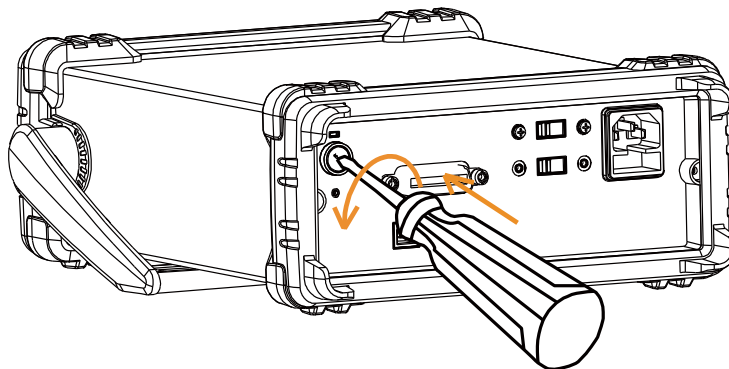

4. The fuse holder comes out. Replace the fuse inserted at the end of the holder followed by rotating the fuser holder clockwise to fasten it firmly.

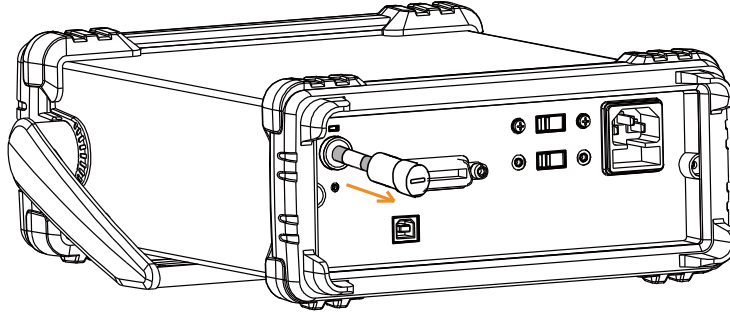

Rating T1.0A, 1000V , 6*30mm

Replace Internal 10A Input Current Fuse

Preparation **Replace internal 10A input fuse** To make sure if 10A input current needs to be replaced, press the **•))** button to set GDM-9041/9042 in Continuity mode and short circuit the HI input terminal with the 10A input current terminal. If the test result shows OPEN, follow the following section to replace fuse of internal 10A input current.

Internal Fuse Spec	Location	Current	Voltage	Type	Dimension
Internal 10A input current fuse	F201	12A	1000V	Fast-blow type	10 x 38mm

- Steps for Internal Fuse Replacement**
1. Power off properly and disconnect all the test leads, cables including power cord.
 2. Disassemble the instrument case in light of the disassembling instructions.
 3. Make sure the certain fuse to be replaced as the figures below shown.

Internal 10A
input
current fuse



4. Pull the fuse out from the fuse holder with a flat-blade screwdriver. Be cautious Not to damage the printed circuit board (PCB).
5. Disassemble the fuse.
6. Place the new fuse into the fuse holder. Gently push the fuse downwards to make it firmly fixed within the fuse holder.
7. Reassemble the instrument properly followed by connecting all the cables and cords.
8. Fuse replacement is completed.

Battery Replacement

Beforehand

This chapter describes the procedure of battery replacement in the front panel.

Before start, it is required to let a certified and trained technician properly aware of potential risks to disassemble instrument case. Unplug power cord and disconnect external circuit from the instrument before opening the case. Some of the electrical connections are dynamic and even available after powering off the instrument.

Consequently, Do disconnect all the inputs, cords and cables before disassembling the instrument.

The steps to replace battery

1. Power off properly and disconnect all the test leads, cables including power cord.
2. Disassemble the instrument case in light of the disassembling instructions.
3. Find the battery (CR2032) on the main board, which is perfectly located in the BT401 behind the transformer.

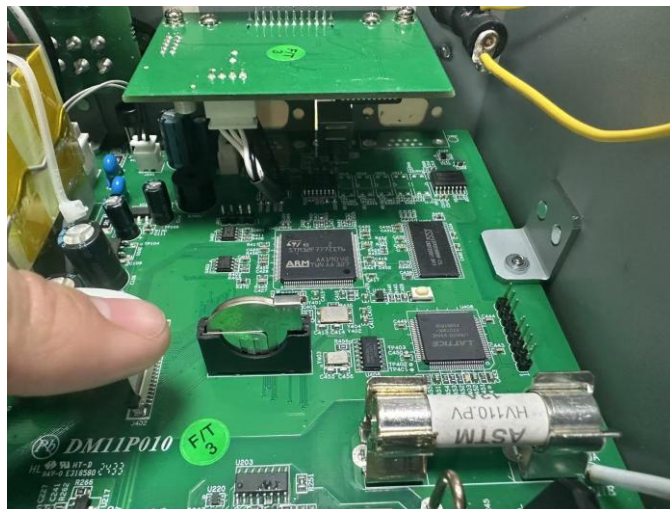





4. Gently remove the metal guard plate on top of the battery followed by pinching the battery out off the compartment with 2 fingers..



5. Remove the battery and dispose or recycle it in accord with the applicable regulations.
 6. Place the new battery (CR2032) into the compartment and beware of the polarity (+, -). “+” is way close to the metal guard plate. Gently press the battery downwards to make it firmly fixed.
 7. Connect every cable and cord in need and reassemble the instrument in proper order. The procedure of battery replacement is completed.
-

Factory Default Parameters

Measurement		
Item List	Factory Default Parameter	Parameter
1ST Function	DCV	✓
1ST Range	Auto Range	✓
1ST Speed	5/s	✓
2ND Function	Off	✓
Filter	Off	✓
Filter Type	Move	✓
Filter Count	10	✓
Filter Window	0.10%	✓
Input Impedance	10M(fixed for DCV)	✓
Freq GateTime	1s	✓
Freq InJack	Voltage	✓
Continuity Threshold	10Ω	✓
Continuity Beep Volume	Small	✓
Temperature		
Item List	Factory Default Parameter	Parameter
Probe	Themocouple	✓
Unit	°C	✓
Themocouple	Type	J
	Simulated junction	23

Math			
Item List	Factory Default	Parameter	
Math Function	Off		✓
	Function	Off	✓
Hold	Beep Volume	Small	✓
	Threshold	0.10%	✓
Rel	Function	Off	✓
dB	Reference Method	dBm	✓
	Reference Resistance	600Ω	✓
dBm	Reference Resistance	600Ω	✓
Compare	Beep Mode	Off	✓
	Beep Volume	Medium	✓
	Low Limit	-1	✓
	High Limit	1	✓
MX+B	M Value	1	✓
	B Value	0	✓
Trigger			
Item List	Factory Default	Parameter	
	Trigger Source	INT	✓
	Sample Count	1	✓

Menu			
Item List		Factory Default Parameter	Parameter
System	Beep	On	✓
	Key Sound	On	✓
	Brightness	50%	✓
	Auto Dim	OFF	✓
	Zero Fill	On	✓
	Factory	Off	✓
Interface	Interface	USB	✓
	USB Protocol	USBCDC	✓
	GPIB Address	15	✓
	Identity	Normal	✓



Only utilized parameters are listed here due to over-amount parameters. The rest of the parameters unlisted, however, can be saved and loaded as well.



It indicates parameters can be saved and loaded.

Specifications

The specifications apply when the DMM is warmed up for at least 30 minutes and operates in slow rate.

Below are the basic conditions required to operate the DMM within specifications:

- Calibration: Yearly
- Operating Temperature Specification: 18 to 28°C (64.4 to 82.4°F)
- Relative Humidity: 80% (Non condensing)
- Accuracy: \pm (% of Reading + Digits)
- AC measurements are based on a 50% duty cycle.
- The power supply cable must be grounded to ensure accuracy.
- All specifications are applicable to the main (1st) display only.

General Specifications

Specification Conditions:

Temperature: 23 °C \pm 5 °C

Humidity: <80% RH, 75% RH for resistance measurement readings greater than 10 M Ω .

Operating Environment: (0 to 50°C)

Temperature Range: 0 to 35 °C, Relative Humidity: <80% RH;

>35 °C, Relative Humidity: <70% RH

Indoor use only

Altitude: 2000 meters

Pollution degree 2

Storage Conditions (-10 to 70 °C)

Temperature Range: 0 to 35 °C, Relative Humidity: <90% RH;

>35 °C, Relative Humidity: <80% RH

General:

Power Consumption: Max 30 VA

Dimensions: 268 mm x 107 mm x 302 mm

Weight: Approximately 3.2 kg

DC Voltage

Range	Resolution	Full Scale	Accuracy (1 year 23 °C ±5 °C)	Input Resistance
500 mV	10 μV	510.00		10 MΩ or >10 GΩ
5 V	100 μV	5.1000		10 MΩ or >10 GΩ
50 V	1 mV	51.000	0.02% +4	11.1 MΩ
500 V	10 mV	510.00		10.1 MΩ
1000 V	100 mV	1020.0		10 MΩ

* When the input value exceeds the full scale of the selected range, the display will show OverLoad on the display.

* The specifications are guaranteed to an input voltage of 1000 V. A beeping alarm will go off when the input voltage is higher than 1000 V.

* Input protection of 1000 V peak on all ranges.

* DC Common Mode Rejection Ratio

>90 dB at dc, 50 or 60 Hz ± 0.1% (1 kΩ unbalanced, slow rates)

DC Current

Range	Resolution	Full Scale	Accuracy (1 year 23 °C ±5 °C)	Shunt Resistance	Burden Voltage
500 μA	10 nA	510.00	0.05% +5	100 Ω	0.06 V max
5 mA	100 nA	5.1000	0.05% +4	100 Ω	0.6 V max
50 mA	1 μA	51.000	0.05% +4	1 Ω	0.14 V max
500 mA	10 μA	510.00	0.10% +4	0.1 Ω	1.4 V max
5 A	100 μA	5.1000	0.25% +5	10 mΩ	0.5 V max
10 A	1 mA	12.000	0.25% +5	10 mΩ	0.8 V max

* 500 μA to 500 mA range has a 3.6 V voltage limit protection and 1 A fuse protection. And 10 A range has a 12 A fuse protection.

* When the input value exceeds the full scale of the selected range, the display will show OverLoad on the display.

* The specifications are guaranteed to an input of 10 A. A beeping alarm will go off when the input value is higher than 10 A.

AC Voltage, ACV+DCV_[3] (AC Coupled)

Range	Resolution	Full Scale	Accuracy (1 year 23°C ±5°C) [1]			
			30 to 50 Hz	50 to 10 kHz	10 K to 30 kHz	30 K to 100 kHz
500 mV	10 µV	510.00	1.00% +40	0.50%+40	2.00% +60	3.00% +120
5 V	100 µV	5.1000	1.00% +20	0.35%+15	1.00% +20	3.00% +50
50 V	1 mV	51.000	1.00% +20	0.35%+15	1.00% +20	3.00% +50
500 V	10 mV	510.00	x	0.5%+15	1.00% +20[2]	3.00% +50[2]
750 V	100 mV	765.0	x	0.5%+15	x	x

[1] Specifications are for sine wave inputs that are greater than 5% range.

[2] Input voltage <300 Vrms.

[3] The accuracy of ACV+DCV is equal to ACV's with 10 more digits added.

* The specifications are guaranteed to an input of 750 V. A beeping alarm will go off when the input value is higher than 750 V.

* Input protection of 1000 V peak on all ranges.

* AC-coupled true RMS – measures the AC component of the input with up to 400 Vdc of bias on any range.

* AC Common Mode Rejection Ratio.

>60 dB at dc, 50 or 60 Hz ± 0.1% (1 kΩ unbalanced, slow rates)

*Input impedance 1 MΩ ±2% in parallel with 100 pF.

AC Current, ACI+DCI_[3] (AC Coupled)

Range	Resolu-tion	Full Scale	Accuracy (1 year 23°C ±5°C) [1]				Burden Voltage
			30 to 50 Hz	50 to 2 kHz	2 K to 5 kHz	5 K to 20 kHz	
500 µA	10 nA	510.00	1.50% +50	0.50% +40	1.50% +50	3.00% +75	0.06V max
5 mA	100 nA	5.1000	1.50% +40	0.50% +20	1.50% +40	3.00% +60	0.6V max
50 mA	1 µA	51.000	1.50% +40	0.50% +20	1.50% +40	3.00% +60	0.14V max
500 mA	10 µA	510.00	1.50% +40	0.50% +20	1.50% +40	3.00% +60[2]	1.4V max
5 A	100 µA	5.1000	2.0% +40	0.50% +30	x	x	0.5V max
10 A	1 mA	12.000	2.0% +40	0.50% +30	x	x	0.8V max

[1] The 500µA range requires an input of >35 µA to meet specifications. The 5 mA to 10A ranges need more than 5% of full scale range to meet specifications.

[2] Input current (5 k to 20 kHz) <330 mArms.

[3] The accuracy of ACI+DCI is equal to ACI's with 10 more digits added.

* The specifications are guaranteed to 10 A. A beeping alarm will go off when the input current being measured is higher than 10 A.

Resistance

Resistance	Resolution	Full Scale	Test Current	Accuracy (1 year 23 °C ±5 °C)[2]
500.00 Ω	10 mΩ	510.00	1 mA	0.1% +5 [1]
5 kΩ	100 mΩ	5.1000	1 mA	0.1% +3 [1]
50 kΩ	1 Ω	51.000	100 μA	0.1% +3
500 kΩ	10 Ω	510.00	10 μA	0.1% +3
5 MΩ	100 Ω	5.1000	1 μA	0.1% +3
100 MΩ	10 KΩ	120.00 M	500 nA//10 MΩ	≤ 50 MΩ: 0.30 +3 > 50 MΩ: 1.75 +3

[1] Using the REL function. If you don't use the REL function then increase the error by 0.2 Ω.

[2] When measuring resistances greater than 500 kΩ, please use shielded test leads to eliminate the noise interference that may be induced by standard test leads.

* Open circuit voltage approximates 6 V max on 500 to 5 MΩ range, approximates 5.5 V max on 100 MΩ range.

* Input protection of 500 V peak on all ranges.

Diode

Range	Resolution	Full Scale	Test Current	Accuracy (1 year 23 °C ±5 °C)
5 V	100 μV	5.1000	1 mA	0.05% +5

* Input protection of 500 V peak. *Open circuit voltage approximates 6 V.

Continuity

Range	Resolution	Full Scale	Test Current	Accuracy (1 year 23 °C ±5 °C)
5000.0 Ω	100 mΩ	5100.0	1 mA	0.1% +5

* Input protection of 500 V peak. *Open circuit voltage approximates 6 V.

Capacitance

Range	Resolution	Full Scale	Test Current	Accuracy (1 year 23 °C ±5 °C) [1]
5 nF: 0.5 to 1 nF [2]	0.001 nF	5.100	10 µA	2.0% +20
5 nF: 1 to 5 nF [2]				2.0% +10
50 nF: 5 to 10 nF [2]	0.01 nF	51.00	10 µA	2.0% +30
50 nF: 10 to 50 nF [2]				2.0% +10
500 nF	0.1 nF	510.0	100 µA	2.0% +4
5 µF	1 nF	5.100	1 mA	
50 µF	10 nF	51.00	1 mA	

[1] For the 5 nF to 50 µF range, make sure that the input is greater than 10% of the range.

[2] For best measurement results, first perform a zeroing of the test leads when the cables are “open” to compensate for the test lead capacitance.

* Input protection of 500 V peak on all ranges.

Frequency

Measurement Range	Accuracy (1 year 23 °C ±5 °C)
10 Hz to 500 Hz	0.01% +5
500 Hz to 500 kHz	0.01% +3
500 kHz to 1 MHz	0.01% +5

* AC + DC measurements do not allow frequency measurements.

* Input protection of 1000 V peak on all ranges.

Voltage Measurement Sensitivity

Range	Minimum Sensitivity (RMS sine wave)		
	10 to 100 kHz	100 k to 500 kHz	500 kHz to 1 MHz
500 mV	35 mV	200 mV	500 mV
5 V	0.25 V	0.5 V	1 V
50 V	2.5 V	5 V	5 V
500 V	25 V	uncal	uncal
750 V	50 V	uncal	uncal

Current Measurement Sensitivity

Range	Minimum Sensitivity (RMS sine wave)
	30 to 20 kHz
500 µA	35 µA
5 mA	0.25 mA

50 mA	2.5 mA
500 mA	25 mA
5 A	0.25 A (<2 kHz)
10 A	2.5 A (<2 kHz)

Temperature Specifications

Sensor	Type	Measurement Range	Resolution	Accuracy (1 year 23 °C ±5 °C)
Thermocouple	J	-200 to +300 °C	0.1 °C	2 °C
	K			
	T			

* Note: The temperature specifications do not include sensor error.

* Note: This feature is not supported on the GDM-9041.

Dimensions

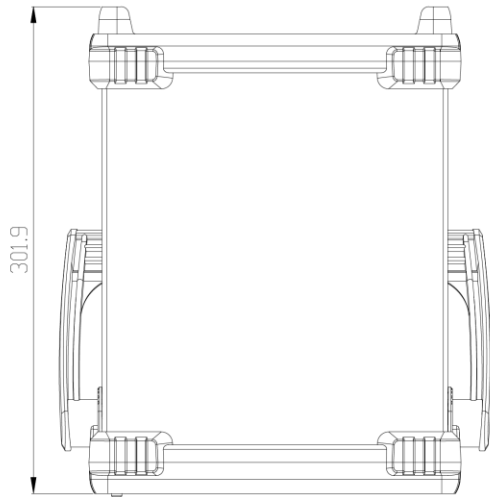

All dimensions are shown in millimeters.

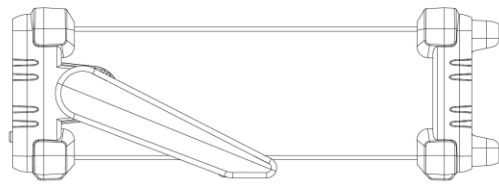
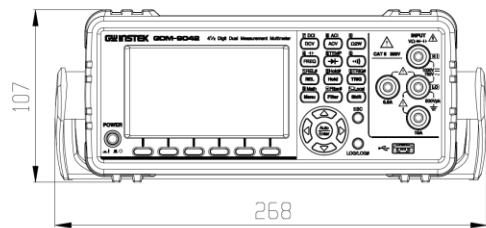

Declaration of Conformity

We

GOOD WILL INSTRUMENT CO., LTD.

declare that the CE marking mentioned product

satisfies all the technical relations application to the product within the scope of council:

Directive: EMC; LVD; WEEE; RoHS

The product is in conformity with the following standards or other normative documents:

© EMC	
EN 61326-1 :	Electrical equipment for measurement, control and laboratory use — EMC requirements
Conducted & Radiated Emission EN 55011 / EN 55032	Electrical Fast Transients EN 61000-4-4
Current Harmonics EN 61000-3-2 / EN 61000-3-12	Surge Immunity EN 61000-4-5
Voltage Fluctuations EN 61000-3-3 / EN 61000-3-11	Conducted Susceptibility EN 61000-4-6
Electrostatic Discharge EN 61000-4-2	Power Frequency Magnetic Field EN 61000-4-8
Radiated Immunity EN 61000-4-3	Voltage Dip/ Interruption EN 61000-4-11 / EN 61000-4-34
© Safety	
EN 61010-1 :	Safety requirements for electrical equipment for measurement, control, and laboratory use - Part 1: General requirements

GOODWILL INSTRUMENT CO., LTD.

No. 7-1, Jhongsing Road, Tucheng District, New Taipei City 236, Taiwan

Tel: [+886-2-2268-0389](tel:+886-2-2268-0389)

Fax: [+886-2-2268-0639](tel:+886-2-2268-0639)

Web: <http://www.gwinstek.com>

Email: marketing@goodwill.com.tw

GOODWILL INSTRUMENT (SUZHOU) CO., LTD.

No. 521, Zhujiang Road, Snd, Suzhou Jiangsu 215011, China

Tel: [+86-512-6661-7177](tel:+86-512-6661-7177)

Fax: [+86-512-6661-7277](tel:+86-512-6661-7277)

Web: <http://www.instek.com.cn>

Email: marketing@instek.com.cn

GOODWILL INSTRUMENT EURO B.V.

De Run 5427A, 5504DG Veldhoven, The Netherlands

Tel: [+31-\(0\)40-2557790](tel:+31-(0)40-2557790)

Fax: [+31-\(0\)40-2541194](tel:+31-(0)40-2541194)

Email: sales@gw-instek.eu

INDEX

Accessories	11	storage	8
Command IEE488.2 commands	145	Frequency	
Command set		setting	42
CALCulate commands	135	Front panel	
CONFigure commands	124	overview	13, 20
CONFigure2 commands	126	fuse	
Measure commands	128	rating	149
Remote commands	144	Fuse	
SENSe commands	131	AC fuse replacement	149
STATus report commands	144	current fuse replacement	150, 151
SYSTem related commands	141	safety instruction	7
TRIGger commands	138	Getting Started chapter	9
Continuity		Indicator	
setting	39, 46	reading	27
Crest factor	32, 33	Main features	10
Current		Math	
setting	34	1/X	84, 86
dB		setting	72, 79, 82, 84, 86
setting	72	Measurement keys	
Declaration of conformity	165	overview	15
Digital filter		Period	
setting	69	setting	42
window	70	Rear panel	
Diode test		overview	18
setting	41	Refresh rate	26, 56
Disposal instructions	8	Relative value	
Dual measurement		setting	64
operation	53	Remote control	
overview	53	Command list	118, 119, 120, 121, 122, 123
EN 61010		Command syntax	114
pollution degree	8	Resistance	
Environment		setting	37
operation	7	Safety instruction	

fuse.....	7	Thermocouple	
symbol.....	5	setting.....	50
Specifications	158	Triggering.....	28
Dimensions.....	164	Voltage	
Status system	147	setting.....	29
Table of contents	3	W	
Temperature		setting.....	72
setting	49, 51		